

CATALOG accessories

# Accessories

*Fittings, Flow Controls, Mufflers, Etc.*



---

<b>Accessories</b> .....	2-42
World Thread Fittings .....	2-6
NPTF/Inch Tube Fittings .....	7-13
Metric Fittings .....	14-19
NPTF Composite Fittings .....	20-23
Composite Metric Fittings .....	24-27
World Thread Flow Controls .....	28
Flow Controls .....	30-32
Pilot Operated Check Valves .....	33
Quick Exhaust, Slide, & Shuttle Valves .....	34
Silencers .....	35-36
Mufflers .....	37
Breather Vent Silencer .....	38
Inlet Filter Strainer .....	38
Check Valves .....	39
Tubing .....	40-42



### How to Order

**INWB 103 – 104 – 022**

#### Fitting Series

INWB = World Thread Inch Tube (All Brass)  
 NW = World Thread Metric Tube (All Brass)

#### Fitting Style

103 = Straight  
 109 = Swivel Elbow  
 109E = Extended Swivel Elbow  
 114 = Swivel Branch Tee  
 116 = Swivel Run Tee

#### Options

(Blank) = BUNA-N O-Ring  
 F = Viton "O" Ring

#### INW Thread Size

020 = 1/8  
 021 = 1/4  
 022 = 3/8  
 023 = 1/2

#### NW Thread Size

000 = 1/8  
 001 = 1/4  
 002 = 3/8  
 003 = 1/2

#### Tube Size

##### Inch

108 = 1/8"  
 532 = 5/32"  
 104 = 1/4"  
 516 = 5/16"  
 308 = 3/8"  
 102 = 1/2"

##### Metric

004 = 4mm  
 005 = 5mm  
 006 = 6mm  
 008 = 8mm  
 010 = 10mm  
 012 = 12mm

\* See Fitting Style Charts on pgs 4-7 for available Tube and Thread Configurations

- Pressure Rating to 265 psi
- Temperature range: -20°F to +176°F (BUNA N O-ring)  
 +230°F (Viton O-ring)
- Tube diameter: 1/8" to 1/2"  
 4mm to 12mm
- Thread size: 1/8" to 1/2"

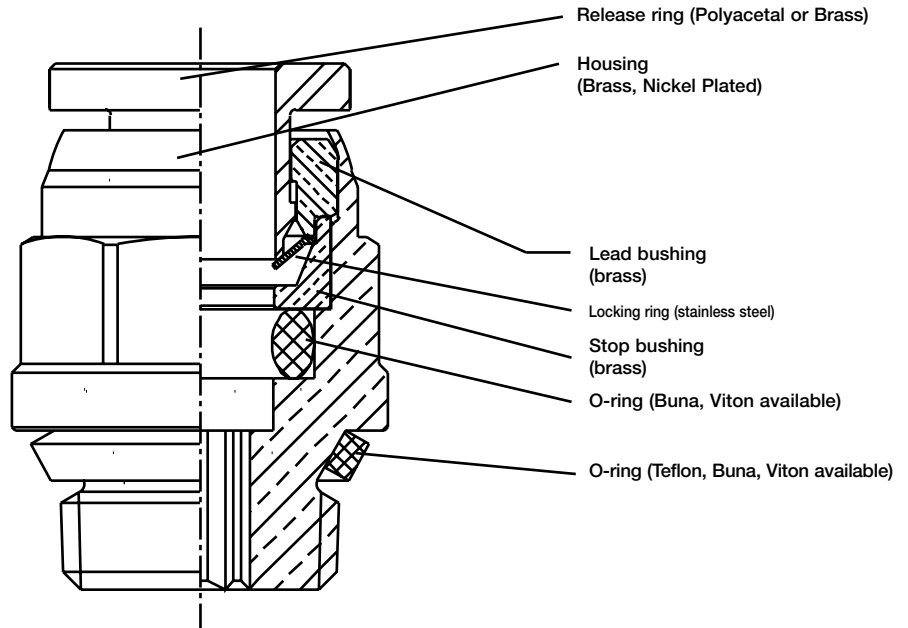

Numatics' World Thread™ IN-Fittings provide extreme versatility in use, which no longer requires the management of different fittings for different thread types or application.

- Extremely versatile – One fitting design for multiple thread types
- Rapid assembly – Requires fewer turns to tighten and seal
- Re-usable – Fittings can be used several times without gasket deterioration
- Reliable seal – Helical thread profile and PTFE gasket ensure proper seal
- Maximum working pressure: 265 PSIG at 68°F (18 bar at 20°C)
- Conductor compatibility – Nylon, Polyurethane, Polyethylene

Numatics' World Tread™ is designed with a helical thread design that represents the envelope for the profile of the NPTF, ISO 228/1(BSPP), (G-Tap), ISO 7/1(BSPT), (JIS B 0202) and (JIS B 0203) thread types. In conjunction with the thread design the seal between the male and female threads is created with a PTFE gasket, housed in a groove at the rear of the thread. This gasket seal meets UNI 571-65 standards.



**World Thread Fittings**

**INWB103 Male Connector/Inch Tube**

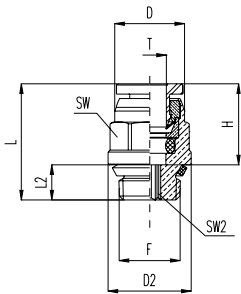

Brass Release Ring	Part Number	Tube Diameter (T)	Thread (F)	D	D2	L	L2	H	SW	SW2
INWB	103-108-020	1/8	1/8	0.370	0.472	0.709	0.217	0.472	0.375	0.063
INWB	103-108-021	1/8	1/4	0.370	0.591	0.787	0.303	0.472	0.375	0.063
INWB	103-532-020	5/32	1/8	0.390	0.512	0.709	0.217	0.492	0.438	0.063
INWB	103-532-021	5/32	1/4	0.390	0.591	0.795	0.303	0.492	0.438	0.063
INWB	103-104-020	1/4	1/8	0.465	0.552	0.799	0.217	0.531	0.500	0.156
INWB	103-104-021	1/4	1/4	0.465	0.591	0.886	0.303	0.531	0.500	0.156
INWB	103-104-022	1/4	3/8	0.465	0.748	0.906	0.323	0.531	0.500	0.156
INWB	103-516-020	5/16	1/8	0.689	0.787	0.925	0.323	0.650	0.594	0.156
INWB	103-516-021	5/16	1/4	0.689	0.945	1.004	0.406	0.650	0.594	0.219
INWB	103-516-022	5/16	3/8	0.807	0.866	1.004	0.303	0.650	0.594	0.219
INWB	103-308-020	3/8	1/8	0.807	0.866	1.043	0.323	0.669	0.688	0.156
INWB	103-308-021	3/8	1/4	0.807	0.945	1.043	0.406	0.669	0.688	0.219
INWB	103-308-022	3/8	3/8	0.807	0.866	1.071	0.323	0.669	0.688	0.250
INWB	103-308-023	3/8	1/2	0.807	0.945	1.161	0.406	0.669	0.688	0.250
INWB	103-102-021	1/2	1/4	0.807	0.945	1.142	0.406	0.728	0.813	0.250
INWB	103-102-022	1/2	3/8	0.807	0.866	1.181	0.323	0.728	0.813	0.250
INWB	103-102-023	1/2	1/2	0.807	0.945	1.220	0.406	0.728	0.813	0.375

**INWB109 Swivel Elbow/Inch Tube**

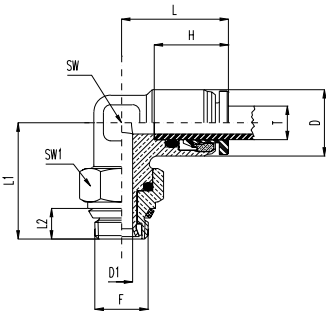

Brass Release Ring	Part Number	Tube Diameter (T)	Thread (F)	D	D1	L	L1	H	L2	SW	SW1
INWB	109-108-020	1/8	1/8	0.394	0.157	0.650	0.768	0.472	0.217	0.354	0.500
INWB	109-108-021	1/8	1/4	0.394	0.157	0.650	0.768	0.472	0.303	0.354	0.594
INWB	109-532-021	5/32	1/4	0.394	0.157	0.669	0.874	0.492	0.303	0.354	0.594
INWB	109-104-020	1/4	1/8	0.472	0.157	0.768	0.799	0.531	0.217	0.433	0.500
INWB	109-104-021	1/4	1/4	0.472	0.236	0.768	0.8155	0.531	0.303	0.433	0.594
INWB	109-516-020	1/4	1/8	0.472	0.236	0.768	0.906	0.531	0.323	0.433	0.750
INWB	109-516-021	5/16	1/4	0.591	0.157	0.945	0.878	0.650	0.217	0.551	0.500
INWB	109-308-020	3/8	1/8	0.689	0.157	1.063	0.929	0.669	0.217	0.630	0.500
INWB	109-308-021	3/8	1/4	0.689	0.236	1.063	0.945	0.669	0.303	0.630	0.594
INWB	109-308-022	3/8	3/8	0.689	0.315	1.063	1.039	0.669	0.323	0.630	0.750
INWB	109-308-023	3/8	1/2	0.689	0.315	1.063	1.197	0.669	0.406	0.630	0.938
INWB	109-102-021	1/2	1/4	0.827	0.236	1.201	1.059	0.728	0.303	0.688	0.594
INWB	109-102-022	1/2	3/8	0.827	0.315	1.201	1.122	0.728	0.323	0.688	0.750
INWB	109-102-023	1/2	1/2	0.827	0.315	1.201	1.280	0.728	0.406	0.688	0.938

**INWB109E Extended Swivel Elbow/Inch Tube**

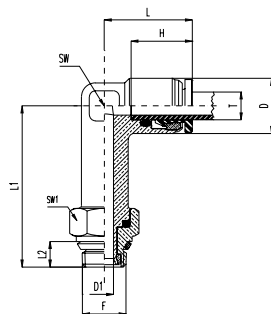

Brass Release Ring	Part Number	Tube Diameter (T)	Thread (F)	D	D1	L	L1	L2	H	SW	SW1
INWB	109E-108-020	1/8	1/8	0.709	0.236	1.043	2.067	0.512	0.531	0.591	0.591
INWB	109E-108-021	1/8	1/4	0.748	0.315	1.043	2.106	0.512	0.531	0.591	0.709
INWB	109E-532-020	5/32	1/8	0.394	0.157	0.638	1.461	0.374	0.472	0.354	0.512
INWB	109E-532-021	5/32	1/4	0.394	0.157	0.638	1.598	0.512	0.472	0.354	0.591
INWB	109E-104-020	1/4	1/8	0.394	0.157	0.657	1.457	0.374	0.492	0.354	0.512
INWB	109E-104-021	1/4	1/4	0.394	0.157	0.657	1.594	0.512	0.492	0.354	0.591
INWB	109E-104-022	1/4	3/8	0.472	0.157	0.740	1.575	0.374	0.531	0.433	0.512
INWB	109E-516-020	5/16	1/8	0.472	0.236	0.740	1.693	0.512	0.531	0.433	0.591
INWB	109E-516-021	5/16	1/4	0.472	0.236	0.740	1.732	0.512	0.531	0.433	0.709
INWB	109E-516-022	5/16	3/8	0.591	0.157	0.925	1.772	0.374	0.531	0.551	0.512
INWB	109E-308-020	3/8	1/8	0.591	0.236	0.925	1.909	0.512	0.531	0.551	0.591
INWB	109E-308-021	3/8	1/4	0.630	0.315	0.925	1.969	0.512	0.531	0.551	0.709
INWB	109E-308-022	3/8	3/8	0.669	0.157	1.043	1.929	0.374	0.531	0.591	0.512



### INWB114 Swivel Branch Tee/Inch Tube

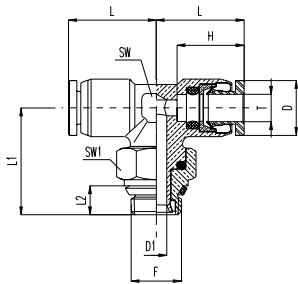

Brass Release Ring	Part Number	Tube Diameter (T)	Thread (F)	D	D1	L	L1	H	L2	SW	SW1
INWB	114-108-020	1/8	1/8	0.394	0.157	0.650	0.768	0.472	0.217	0.354	0.500
INWB	114-108-021	1/8	1/4	0.394	0.157	0.650	0.787	0.472	0.303	0.354	0.594
INWB	114-532-020	5/32	1/8	0.394	0.157	0.669	0.768	0.492	0.217	0.354	0.500
INWB	114-104-020	1/4	1/8	0.472	0.157	0.768	0.886	0.531	0.217	0.433	0.500
INWB	114-104-021	1/4	1/4	0.472	0.236	0.768	0.906	0.531	0.303	0.433	0.594
INWB	114-104-022	1/4	3/8	0.472	0.236	0.768	0.965	0.531	0.323	0.433	0.750
INWB	114-516-020	5/16	1/8	0.591	0.157	0.945	0.874	0.650	0.217	0.551	0.500
INWB	114-516-021	5/16	1/4	0.591	0.236	0.945	0.886	0.650	0.303	0.551	0.594
INWB	114-308-020	3/8	1/8	0.689	0.157	1.063	0.925	0.669	0.217	0.630	0.500
INWB	114-308-021	3/8	1/4	0.689	0.236	1.063	0.945	0.669	0.303	0.630	0.594
INWB	114-308-022	3/8	3/8	0.689	0.315	1.063	1.043	0.669	0.323	0.630	0.750
INWB	114-308-023	3/8	1/2	0.689	0.315	1.063	1.201	0.669	0.406	0.630	0.938
INWB	114-102-021	1/2	1/4	0.827	0.236	1.201	1.063	0.728	0.303	0.688	0.594
INWB	114-102-022	1/2	3/8	0.827	0.315	1.201	1.122	0.728	0.323	0.688	0.750
INWB	114-102-023	1/2	1/2	0.827	0.315	1.201	1.280	0.728	0.406	0.688	0.938

### INWB116 Swivel Run Tee/Inch Tube

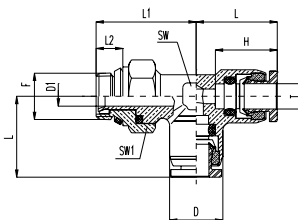

Brass Release Ring	Part Number	Tube Diameter (T)	Thread (F)	D	D1	L	L1	H	L2	SW	SW1
INWB	116-108-020	1/8	1/8	0.394	0.157	0.650	0.768	0.472	0.217	0.354	0.500
INWB	116-532-020	5/32	1/8	0.394	0.157	0.650	0.768	0.492	0.217	0.354	0.500
INWB	116-532-021	5/32	1/4	0.394	0.157	0.638	0.787	0.492	0.303	0.354	0.594
INWB	116-104-020	1/4	1/8	0.472	0.157	0.638	0.886	0.531	0.217	0.433	0.500
INWB	116-104-021	1/4	1/4	0.472	0.236	0.657	0.906	0.531	0.303	0.433	0.594
INWB	116-104-022	1/4	3/8	0.472	0.236	0.657	0.965	0.531	0.323	0.433	0.750
INWB	116-516-020	5/16	1/8	0.591	0.157	0.740	0.874	0.650	0.217	0.551	0.500
INWB	116-516-021	5/16	1/4	0.591	0.236	0.740	0.886	0.650	0.303	0.551	0.594
INWB	116-308-021	3/8	1/4	0.689	0.236	0.925	0.945	0.669	0.303	0.630	0.594
INWB	116-308-022	3/8	3/8	0.689	0.315	0.925	1.043	0.669	0.323	0.630	0.750
INWB	116-308-023	3/8	1/2	0.689	0.315	0.925	1.201	0.669	0.406	0.630	0.938
INWB	116-102-021	1/2	1/4	0.827	0.236	1.043	1.063	0.728	0.303	0.688	0.594
INWB	116-102-022	1/2	3/8	0.827	0.315	1.043	1.122	0.728	0.323	0.688	0.750
INWB	116-102-023	1/2	1/2	0.827	0.315	1.043	1.280	0.728	0.406	0.688	0.938



## World Thread Fittings

### NWB103 Male Connector/Metric Tube

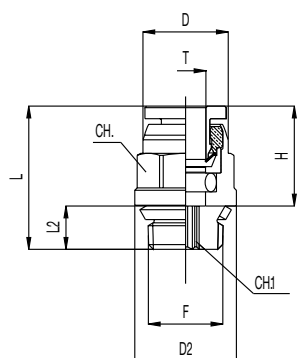

NWB103	Tube Diameter (T)	Thread (F)	D	D2	L	L2	H	CH	CH1
NWB103-004-000	4	1/8	10.0	12	17.5	5.5	12.5	10	3
NWB103-004-001	4	1/4	10.0	15	20.5	7.7	12.5	10	3
NWB103-005-000	5	1/8	11.0	12	18.5	5.5	13.0	11	3
NWB103-005-001	5	1/4	11.0	15	21.0	7.7	13.0	11	3
NWB103-006-000	6	1/8	12.0	14	19.0	5.5	13.5	12	4
NWB103-006-001	6	1/4	12.0	15	21.0	7.7	13.5	12	4
NWB103-008-000	8	1/8	15.0	16	23.5	5.5	16.0	15	5
NWB103-008-001	8	1/4	15.0	16	23.5	7.7	16.0	15	6
NWB103-008-002	8	3/8	15.0	19	24.5	8.2	16.0	15	6
NWB103-010-001	10	1/4	17.5	20	27.0	7.7	17.0	18	6
NWB103-010-002	10	3/8	17.5	20	25.0	8.2	17.0	18	7
NWB103-010-003	10	1/2	17.5	24	28.5	10.3	17.0	18	7
NWB103-012-001	12	1/4	20.5	22	28.0	7.7	19.0	20	6
NWB103-012-002	12	3/8	20.5	22	28.5	8.2	19.0	20	8
NWB103-012-003	12	1/2	20.5	24	31.0	10.3	19.0	20	9

### NWB109 Swivel Elbow/Metric Tube

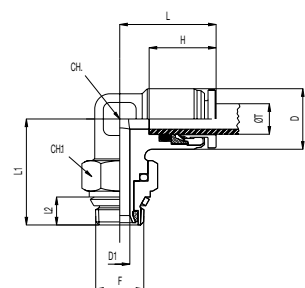

NWB109	Tube Diameter (T)	Thread (F)	D	D1	L	L1	H	L2	CH	CH1
NWB109-004-000	4	1/8	10.0	4	16.5	19.5	12.5	5.5	9	13
NWB109-004-001	4	1/4	10.0	4	16.5	20.0	12.5	7.7	9	15
NWB109-005-000	5	1/8	11.0	4	16.5	21.0	13.0	5.5	10	13
NWB109-005-001	5	1/4	11.0	4	16.5	21.5	13.0	7.7	10	15
NWB109-006-000	6	1/8	12.0	4	19.0	20.5	13.5	5.5	11	13
NWB109-006-001	6	1/4	12.0	4	19.0	21.0	13.5	7.7	11	15
NWB109-008-000	8	1/8	15.0	4	23.5	22.5	16.0	5.5	14	13
NWB109-008-001	8	1/4	15.0	6	23.5	23.0	16.0	7.7	14	15
NWB109-008-002	8	3/8	15.0	8	23.5	25.5	16.0	8.2	14	19
NWB109-010-001	10	1/4	17.5	6	26.5	23.7	17.0	7.7	16	15
NWB109-010-002	10	3/8	17.5	8	26.5	26.4	17.0	8.2	16	19
NWB109-010-003	10	1/2	17.5	8	26.5	30.5	16.8	11.8	16	19
NWB109-012-001	12	1/4	20.5	6	29.1	27.1	18.6	7.7	17	15
NWB109-012-002	12	3/8	20.5	8	29.1	28.5	18.6	8.2	17	19
NWB109-012-003	12	1/2	20.5	8	29.1	32.5	17.0	8.2	15	19

### NWB109E Extended Swivel Elbow/Metric Tube

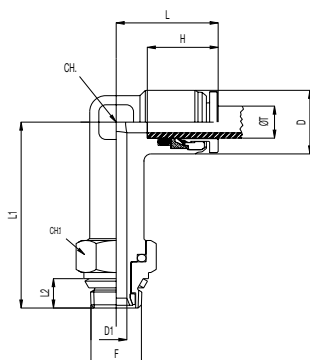

NWB109E	Tube Diameter (T)	Thread (F)	D	D1	L	L1	H	L2	CH	CH1
NWB109E-004-000	4	1/8	10.0	4	16.5	34.5	12.5	5.5	9	13
NWB109E-004-001	4	1/4	10.0	4	16.5	35	12.5	7.7	9	15
NWB109E-006-000	6	1/8	12.0	4	19	37.5	13.5	5.5	11	13
NWB109E-006-001	6	1/4	12.0	6	19	38	13.5	7.7	11	15
NWB109E-008-000	8	1/8	15.0	4	23.5	42.5	16	5.5	14	13
NWB109E-008-001	8	1/4	15.0	6	23.5	42.5	16	7.7	14	15
NWB109E-008-002	8	3/8	15.0	8	23.5	45.2	16	8.2	14	19
NWB109E-010-001	10	1/4	17.5	6	26.5	46.5	17	7.7	15	15
NWB109E-010-002	10	3/8	17.5	8	26.5	49	17	8.2	14	19



### NWB114 Swivel Branch Tee/Metric Tube

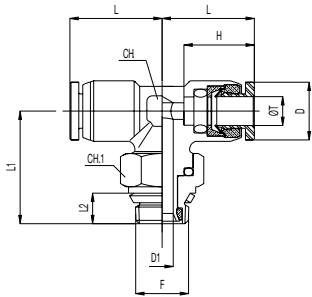

NWB114	Tube Diameter (T)	Thread (F)	D	D1	L	L1	H	L2	SW	SW1
NWB114-004-000	4	1/8	10.0	4	16.5	19.5	12.5	5.5	9	13
NWB114-005-000	5	1/8	11.0	4	16.5	21.0	13.0	5.5	10	13
NWB114-006-000	6	1/8	12.0	4	19.0	22.7	13.5	5.5	11	13
NWB114-006-001	6	1/4	12.0	6	19.0	23.6	13.5	7.7	11	15
NWB114-008-000	8	1/8	15.0	4	23.5	22.3	16.0	5.5	14	13
NWB114-008-001	8	1/4	15.0	6	23.5	22.5	16.0	7.7	14	15
NWB114-008-002	8	3/8	15.0	8	23.5	25.2	16.0	8.2	14	19
NWB114-010-001	10	1/4	17.5	6	26.5	23.7	17.0	7.7	15	15
NWB114-010-002	10	3/8	17.5	8	26.5	28.5	17.0	8.2	15	19
NWB114-010-003	10	1/2	17.5	8	26.5	26.5	16.8	8.2	16	19
NWB114-012-001	12	1/4	20.5	6	29.1	27.1	17.0	7.7	15	15
NWB114-012-002	12	3/8	20.5	8	29.1	28.5	17.0	8.2	15	19
NWB114-012-003	12	1/2	20.5	8	29.1	32.5	17.0	8.2	15	19

### NWB116 Swivel Run Tee/Metric Tube

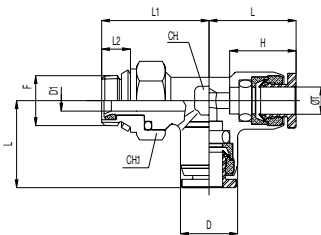

NWB116	Tube Diameter (T)	Thread (F)	D	D1	L	L1	H	L2	SW	SW1
NWB116-004-000	4	1/8	10.0	4	16.5	19.5	12.5	5.5	9	13
NWB116-005-000	5	1/8	11.0	4	16.5	19.6	13.0	5.5	10	13
NWB116-006-000	6	1/8	12.0	4	19.0	22.3	13.5	5.5	11	13
NWB116-006-001	6	1/4	12.0	6	19.0	23.6	13.5	7.7	11	15
NWB116-008-000	8	1/8	15.0	4	23.2	22.3	16.0	5.5	14	13
NWB116-008-001	8	1/4	15.0	6	23.2	22.5	16.0	7.7	14	15
NWB116-008-002	8	3/8	15.0	8	23.4	25.2	16.0	8.2	14	19
NWB116-010-001	10	1/4	17.5	6	26.5	23.7	17.0	7.7	15	15
NWB116-010-002	10	3/8	17.5	8	26.5	26.4	17.0	8.2	15	19
NWB116-010-003	10	1/2	17.5	8	26.5	26.5	16.8	8.2	16	19
NWB116-012-001	12	1/4	20.5	6	29.1	27.1	17.0	7.7	15	15
NWB116-012-002	12	3/8	20.5	8	29.1	28.5	17.0	8.2	15	19
NWB116-012-003	12	1/2	20.5	8	29.1	32.5	17.0	8.2	15	19



## NPTF/Inch Tube Fittings

### How to Order

**INB 109 – 104 – 022**

#### Fitting Series

- INB = NPTF/Inch Table  
(Brass Release Ring)
- \*IN = NPTF/Inch Tube

#### Fitting Style

- 100 = Union
- 101 = Bulkhead Union
- 103 = Male Connector
- 105 = Female Connector
- 106 = Union Elbow
- 107 = Fixed Elbow
- 109 = Swivel Elbow
- 109E = Extended Swivel Elbow
- 110 = Union Tee
- 114 = Swivel Branch Tee
- 116 = Swivel Run Tee
- \*118 = Plug
- \*119 = Double Male Union
- \*120 = Stem Adapter
- 121 = Reducer
- 122 = Single Banjo
- 123 = Double Banjo
- \*124 = Single Manifold
- \*125 = Double Manifold
- 131 = Union Y
- 132 = Male Y

#### Options

- (Blank) = BUNA-N O-Ring
- F = Viton "O" Ring

#### Thread Size

- 000 = No Thread
- 036 = 10-32 UNF
- 020 = 1/8 NPTF
- 021 = 1/4 NPTF
- 022 = 3/8 NPTF
- 023 = 1/2 NPTF

#### Tube Size

- 108 = 1/8"
- 532 = 5/32"
- 104 = 1/4"
- 516 = 5/16"
- 308 = 3/8"
- 102 = 1/2"
- 000 = No Tube

\* See Fitting Style Charts on pgs 9-14 for available Tube and Thread Configurations

\*Fittings with asterisk only available in "IN" Fitting Series.  
All other styles only available in "INB" Fitting Series

- Pressure Rating to 265 psi
- Temperature range: -20°F to +176°F (BUNA N O-ring)  
+230°F (Viton O-ring)
- Push-in fittings with NPTF Threads
- Teflon thread sealant
- Tube diameter: 1/8" to 1/2"
- Thread size: 10-32 UNF to 1/2 NPTF

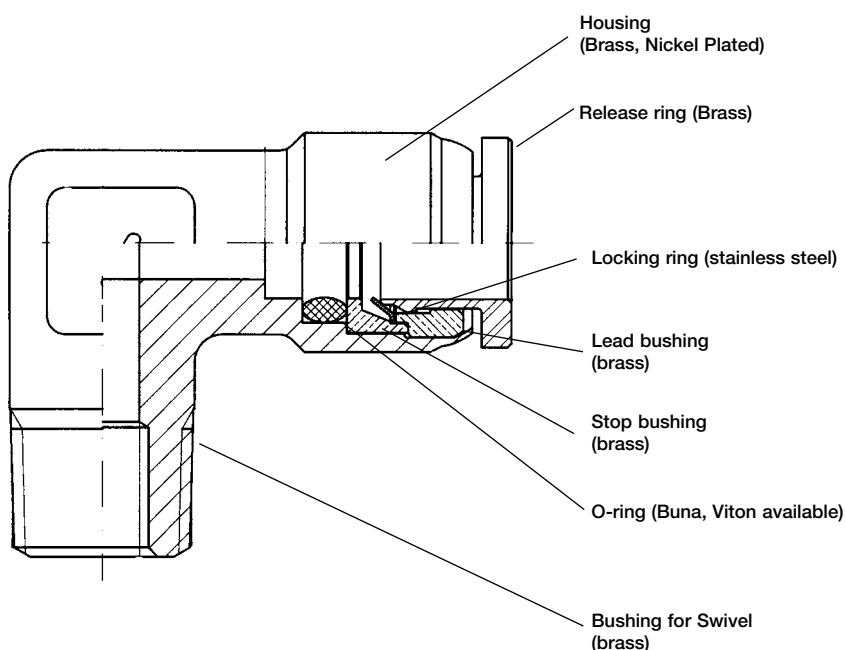





### INB100 Union

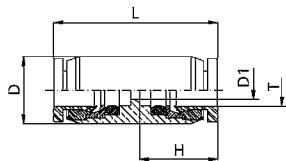

Brass Release Ring	INB100	Tube Diameter (T)	D	D1	L	H
INB	100-108-000	1/8	0.394	0.094	0.984	0.472
INB	100-532-000	5/32	0.394	0.118	1.024	0.492
INB	100-104-000	1/4	0.472	0.157	1.110	0.531
INB	100-516-000	5/16	0.591	0.236	1.299	0.630
INB	100-308-000	3/8	0.709	0.276	1.398	0.669
INB	100-102-000	1/2	0.787	0.413	1.575	0.748

### INB101 Bulkhead Union

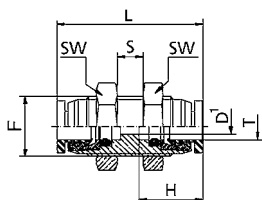

Brass Release Ring	INB101	Tube Diameter (T)	Thread (F)	D1	L	H	SW	S MAX
INB	101-108-000	1/8	M11x1	0.094	1.091	0.472	0.551	0.197
INB	101-532-000	5/32	M12x1	0.118	1.130	0.492	0.551	0.236
INB	101-104-000	1/4	M13x1	0.157	1.244	0.531	0.630	0.315
INB	101-516-000	5/16	M16x1	0.236	1.437	0.630	0.748	0.315
INB	101-308-000	3/8	M19x1	0.276	1.614	0.669	0.866	0.433
INB	101-102-000	1/2	M22x1	0.413	1.850	0.748	1.024	0.591

### INB103 Male Connector

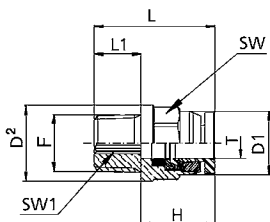

Brass Release Ring	INB103	Tube Diameter (T)	Thread (F)	D1	D2	L	L1	H	SW	SW1
INB	103-108-036	1/8	10-32 UNF	0.370	0.370	0.697	0.165	0.472	/	5/64
INB	103-108-020	1/8	1/8 NPTF	0.370	0.472	0.854	0.374	0.472	3/8	5/64
INB	103-108-021	1/8	1/4 NPTF	0.370	0.551	0.992	0.512	0.472	3/8	5/64
INB	103-532-036	5/32	10-32 UNF	0.394	0.394	0.717	0.165	0.492	/	5/64
INB	103-532-020	5/32	1/8 NPTF	0.394	0.512	0.866	0.374	0.492	7/16	5/64
INB	103-532-021	5/32	1/4 NPTF	0.394	0.551	1.004	0.512	0.492	7/16	5/64
INB	103-104-036	1/4	10-32 UNF	0.472	0.472	0.772	0.165	0.531	/	5/64
INB	103-104-020	1/4	1/8 NPTF	0.472	0.551	0.886	0.374	0.531	1/2	5/32
INB	103-104-021	1/4	1/4 NPTF	0.472	0.551	1.024	0.512	0.531	1/2	5/32
INB	103-104-022	1/4	3/8 NPTF	0.472	0.709	1.024	0.512	0.531	1/2	5/32
INB	103-516-020	5/16	1/8 NPTF	0.591	0.669	1.055	0.374	0.630	19/32	7/32
INB	103-516-021	5/16	1/4 NPTF	0.591	0.669	1.173	0.512	0.630	19/32	7/32
INB	103-516-022	5/16	3/8 NPTF	0.591	0.709	1.173	0.512	0.630	19/32	7/32
INB	103-308-020	3/8	1/8 NPTF	0.669	0.787	1.114	0.374	0.669	11/16	7/32
INB	103-308-021	3/8	1/4 NPTF	0.669	0.787	1.232	0.512	0.669	11/16	1/4
INB	103-308-022	3/8	3/8 NPTF	0.669	0.787	1.232	0.512	0.669	11/16	1/4
INB	103-308-023	3/8	1/2 NPTF	0.669	0.866	1.390	0.709	0.669	11/16	1/4
INB	103-102-021	1/2	1/4 NPTF	0.827	0.906	1.339	0.512	0.748	13/16	1/4
INB	103-102-022	1/2	3/8 NPTF	0.827	0.906	1.339	0.512	0.748	13/16	3/8
INB	103-102-023	1/2	1/2 NPTF	0.827	0.906	1.496	0.709	0.748	13/16	3/8

### INB105 Female Connector

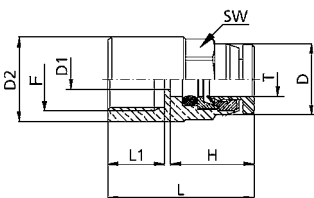

Brass Release Ring	INB105	Tube Diameter (T)	Thread (F)	D	D1	D2	L	L2	H	SW
INB	105-108-020	1/8	1/8 NPTF	0.370	0.094	0.551	0.945	0.335	0.472	3/8
INB	105-108-021	1/8	1/4 NPTF	0.370	0.094	0.669	1.102	0.472	0.472	3/8
INB	105-532-020	5/32	1/8 NPTF	0.394	0.118	0.551	0.965	0.335	0.492	7/16
INB	105-532-021	5/32	1/4 NPTF	0.394	0.118	0.669	1.122	0.472	0.492	7/16
INB	105-104-020	1/4	1/8 NPTF	0.472	0.157	0.551	0.965	0.335	0.531	1/2
INB	105-104-021	1/4	1/4 NPTF	0.472	0.157	0.669	1.142	0.472	0.531	1/2
INB	105-516-020	5/16	1/8 NPTF	0.591	0.236	0.669	1.055	0.335	0.630	19/32
INB	105-516-021	5/16	1/4 NPTF	0.591	0.236	0.669	1.213	0.472	0.630	19/32
INB	105-308-021	3/8	1/4 NPTF	0.669	0.276	0.866	1.248	0.472	0.669	3/4
INB	105-308-022	3/8	3/8 NPTF	0.669	0.276	0.866	1.366	0.495	0.669	11/16

## NPTF/Inch Tube Fittings

### INB106 Union Elbow

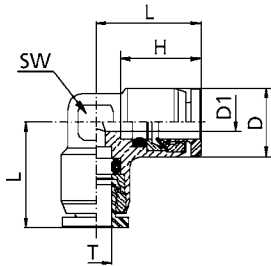

Brass Release Ring	INB106	Tube Diameter (T)	D	D1	L	H	SW
INB	106-108-000	1/8	0.394	0.094	0.638	0.472	0.354
INB	106-532-000	5/32	0.394	0.118	0.657	0.492	0.354
INB	106-104-000	1/4	0.472	0.157	0.740	0.531	0.433
INB	106-516-000	5/16	0.591	0.236	0.858	0.630	0.551
INB	106-308-000	3/8	0.709	0.295	1.004	0.669	0.630
INB	106-102-000	1/2	0.827	0.413	1.161	0.748	0.685

### INB107 Fixed Elbow

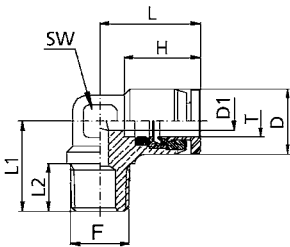

Brass Release Ring	INB107	Tube Diameter (T)	Thread (F)	D	D1	L	L1	L2	H	SW
INB	107-532-020	5/32	1/8 NPTF	0.394	0.118	0.657	0.650	0.374	0.492	0.354
INB	107-532-021	5/32	1/4 NPTF	0.394	0.118	0.657	0.787	0.512	0.492	0.354
INB	107-104-020	1/4	1/8 NPTF	0.472	0.157	0.740	0.693	0.374	0.531	0.433
INB	107-104-021	1/4	1/4 NPTF	0.472	0.157	0.740	0.831	0.512	0.531	0.433
INB	107-308-021	3/8	1/4 NPTF	0.709	0.295	1.004	0.945	0.512	0.685	0.630
INB	107-308-022	3/8	3/8 NPTF	0.709	0.295	1.004	1.945	0.512	0.685	0.630

### INB109 Swivel Elbow

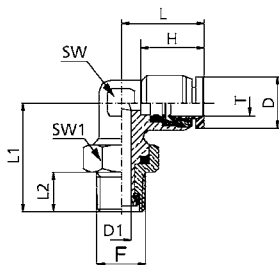

Brass Release Ring	INB109	Tube Diameter (T)	Thread (F)	D	D1	L	L1	L2	H	SW	SW1
INB	109-108-036	1/8	10-32 UNF	0.394	0.087	0.638	0.630	0.165	0.472	0.354	0.354
INB	109-108-020	1/8	1/8 NPTF	0.394	0.157	0.638	0.874	0.374	0.472	0.354	0.512
INB	109-108-021	1/8	1/4 NPTF	0.394	0.157	0.638	1.008	0.512	0.472	0.354	0.591
INB	109-532-036	5/32	10-32 UNF	0.394	0.087	0.657	0.630	0.165	0.492	0.354	0.354
INB	109-532-020	5/32	1/8 NPTF	0.394	0.157	1.657	0.874	0.374	0.492	0.354	0.512
INB	109-532-021	5/32	1/4 NPTF	0.394	0.157	1.657	1.008	0.512	0.492	0.354	0.591
INB	109-104-036	1/4	10-32 UNF	0.472	0.087	0.740	0.709	0.165	0.531	0.433	0.354
INB	109-104-020	1/4	1/8 NPTF	0.472	0.157	0.740	0.906	0.374	0.531	0.433	0.512
INB	109-104-021	1/4	1/4 NPTF	0.472	0.236	0.740	1.031	0.512	0.531	0.433	0.591
INB	109-104-022	1/4	3/8 NPTF	0.472	0.236	0.740	1.071	0.512	0.531	0.433	0.709
INB	109-516-020	5/16	1/8 NPTF	0.591	0.157	0.925	0.984	0.374	0.630	0.551	0.512
INB	109-516-021	5/16	1/4 NPTF	0.591	0.236	0.925	1.122	0.512	0.630	0.551	0.591
INB	109-516-022	5/16	3/8 NPTF	0.591	0.315	0.925	1.181	0.512	0.630	0.551	0.709
INB	109-308-020	3/8	1/8 NPTF	0.709	0.157	1.043	1.043	0.374	0.669	0.630	0.512
INB	109-308-021	3/8	1/4 NPTF	0.709	0.236	1.043	1.181	0.512	0.669	0.630	0.591
INB	109-308-022	3/8	3/8 NPTF	0.709	0.315	1.043	1.220	0.512	0.669	0.630	0.709
INB	109-308-023	3/8	1/2 NPTF	0.709	0.315	1.043	1.358	0.709	0.669	0.630	0.866
INB	109-102-021	1/2	1/4 NPTF	0.827	0.236	1.181	1.299	0.512	0.748	0.685	0.591
INB	109-102-022	1/2	3/8 NPTF	0.827	0.315	1.181	1.299	0.512	0.748	0.685	0.709
INB	109-102-023	1/2	1/2 NPTF	0.827	0.315	1.181	1.476	0.709	0.748	0.685	0.866



### INB109E Extended Swivel Elbow

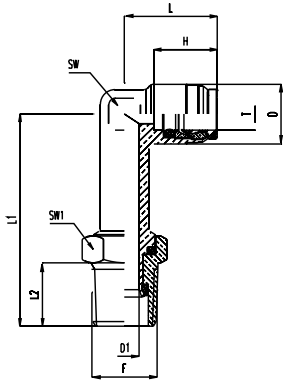

Brass Release Ring	INB109E	Tube Diameter (T)	Thread (F)	D	D1	L	L1	L2	H	SW	SW1
INB	109E-108-020	1/8	1/8 NPTF	0.394	0.157	0.638	1.461	0.374	0.472	0.354	0.512
INB	109E-108-021	1/8	1/4 NPTF	0.394	0.157	0.638	1.598	0.512	0.472	0.354	0.591
INB	109E-532-020	5/32	1/8 NPTF	0.394	0.157	0.657	1.457	0.374	0.492	0.354	0.512
INB	109E-104-020	1/4	1/8 NPTF	0.472	0.157	0.740	1.575	0.374	0.531	0.433	0.512
INB	109E-104-021	1/4	1/4 NPTF	0.472	0.236	0.740	1.693	0.512	0.531	0.433	0.591
INB	109E-104-022	1/4	3/8 NPTF	0.472	0.236	0.740	1.732	0.512	0.531	0.433	0.709
INB	109E-516-021	5/16	1/4 NPTF	0.591	0.236	0.925	1.909	0.512	0.531	0.551	0.591
INB	109E-308-020	3/8	1/8 NPTF	0.669	0.157	1.043	1.929	0.374	0.531	0.591	0.512
INB	109E-308-021	3/8	1/4 NPTF	0.709	0.236	1.043	2.067	0.512	0.531	0.591	0.591
INB	109E-308-022	3/8	3/8 NPTF	0.748	0.315	1.043	2.106	0.512	0.531	0.591	0.709

### INB110 Union Tee

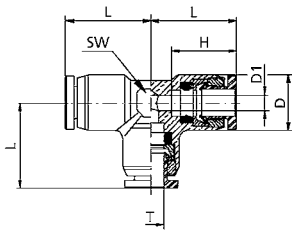

Brass Release Ring	INB110	Tube Diameter (T)	D	D1	L	H	SW
INB	110-108-000	1/8	0.394	0.094	0.638	0.472	0.354
INB	110-532-000	5/32	0.394	0.118	0.657	0.492	0.354
INB	110-104-000	1/4	0.472	0.157	0.740	0.531	0.433
INB	110-516-000	5/16	0.591	0.236	0.858	0.630	0.551
INB	110-308-000	3/8	0.709	0.295	1.004	0.669	0.630
INB	110-102-000	1/2	0.827	0.413	1.161	0.748	0.685

### INB114 Swivel Branch Tee

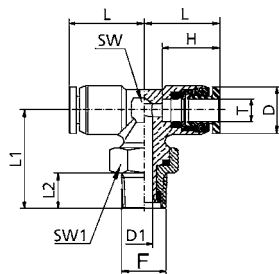

Brass Release Ring	INB114	Tube Diameter (T)	Thread (F)	D	D1	L	L1	L2	H	SW	SW1
INB	114-108-036	1/8	10-32 UNF	0.394	0.087	0.638	0.630	0.165	0.472	0.354	0.354
INB	114-108-020	1/8	1/8 NPTF	0.394	0.157	0.638	0.874	0.374	0.472	0.354	0.512
INB	114-108-021	1/8	1/4 NPTF	0.394	0.157	0.638	1.008	0.512	0.472	0.354	0.591
INB	114-532-036	5/32	10-32 UNF	0.394	0.087	0.657	0.630	0.165	0.492	0.354	0.354
INB	114-532-020	5/32	1/8 NPTF	0.394	0.157	0.657	0.874	0.374	0.492	0.354	0.512
INB	114-532-021	5/32	1/4 NPTF	0.394	0.157	0.657	1.008	0.512	0.492	0.354	0.591
INB	114-104-020	1/4	1/8 NPTF	0.472	0.157	0.740	0.996	0.374	0.531	0.433	0.512
INB	114-104-021	1/4	1/4 NPTF	0.472	0.236	0.740	1.142	0.512	0.531	0.433	0.591
INB	114-104-022	1/4	3/8 NPTF	0.472	0.236	0.740	1.181	0.512	0.531	0.433	0.709
INB	114-516-020	5/16	1/8 NPTF	0.591	0.157	0.925	0.984	0.374	0.630	0.551	0.512
INB	114-516-021	5/16	1/4 NPTF	0.591	0.236	0.925	1.122	0.512	0.630	0.551	0.591
INB	114-308-020	3/8	1/8 NPTF	0.709	0.157	1.043	1.043	0.374	0.669	0.630	0.709
INB	114-308-021	3/8	1/4 NPTF	0.709	0.236	1.043	1.181	0.512	0.669	0.630	0.591
INB	114-308-022	3/8	3/8 NPTF	0.709	0.315	1.043	1.220	0.512	0.699	0.630	0.709
INB	114-308-023	3/8	1/2 NPTF	0.709	0.315	1.043	1.394	0.709	0.699	0.630	0.866
INB	114-102-021	1/2	1/4 NPTF	0.827	0.236	1.181	1.299	0.512	0.748	0.685	0.591
INB	114-102-022	1/2	3/8 NPTF	0.827	0.315	1.181	1.299	0.512	0.748	0.685	0.709
INB	114-102-023	1/2	1/2 NPTF	0.827	0.315	1.181	1.476	0.709	0.748	0.685	0.866



## NPTF/Inch Tube Fittings

### INB116 Swivel Run Tee

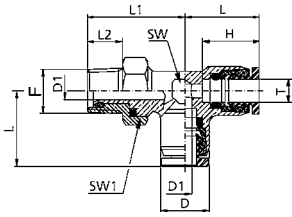

Brass Release Ring	INB116	Tube Diameter (T)	Thread (F)	D	D1	L	L1	L2	H	SW	SW1
INB	116-108-036	1/8	10-32 UNF	0.394	0.087	0.638	0.630	0.165	0.472	0.354	0.354
INB	116-108-020	1/8	1/8 NPTF	0.394	0.157	0.638	0.874	0.374	0.472	0.354	0.512
INB	116-108-021	1/8	1/4 NPTF	0.394	0.157	0.638	1.008	0.512	0.472	0.354	0.591
INB	116-532-036	5/32	10-32 UNF	0.394	0.087	0.657	0.630	0.165	0.492	0.354	0.354
INB	116-532-020	5/32	1/8 NPTF	0.394	0.157	0.657	0.874	0.374	0.492	0.354	0.512
INB	116-532-021	5/32	1/4 NPTF	0.394	0.157	0.657	1.008	0.512	0.492	0.354	0.591
INB	116-104-020	1/4	1/8 NPTF	0.472	0.157	0.740	0.996	0.374	0.531	0.433	0.512
INB	116-104-021	1/4	1/4 NPTF	0.472	0.236	0.740	1.142	0.512	0.531	0.433	0.591
INB	116-104-022	1/4	3/8 NPTF	0.472	0.236	0.740	1.181	0.512	0.531	0.433	0.709
INB	116-516-020	5/16	1/8 NPTF	0.591	0.157	0.925	0.984	0.374	0.630	0.551	0.512
INB	116-516-021	5/16	1/4 NPTF	0.591	0.236	0.925	1.122	0.512	0.630	0.551	0.591
INB	116-308-020	3/8	1/8 NPTF	0.709	0.157	1.043	1.043	0.374	0.669	0.630	0.512
INB	116-308-021	3/8	1/4 NPTF	0.709	0.236	1.043	1.181	0.512	0.669	0.630	0.591
INB	116-308-022	3/8	3/8 NPTF	0.709	0.315	1.043	1.220	0.512	0.699	0.630	0.709
INB	116-308-023	3/8	1/2 NPTF	0.709	0.315	1.043	1.394	0.709	0.699	0.630	0.866
INB	116-102-021	1/2	1/4 NPTF	0.827	0.236	1.181	1.299	0.512	0.748	0.685	0.591
INB	116-102-022	1/2	3/8 NPTF	0.827	0.315	1.181	1.299	0.512	0.748	0.685	0.709
INB	116-102-023	1/2	1/2 NPTF	0.827	0.315	1.181	1.476	0.709	0.748	0.685	0.866

### IN118 Plug

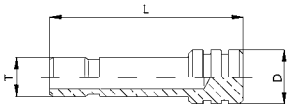

IN118	T	D	L
IN118-108-000	1/8	0.197	0.827
IN118-532-000	5/32	0.236	0.906
IN118-104-000	1/4	0.315	0.984
IN118-516-000	5/16	0.394	1.063
IN118-308-000	3/8	0.472	1.102
IN118-102-000	1/2	0.591	1.260

### IN119 Double Male Union

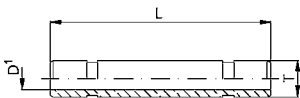

IN119	T	D1	L
IN119-108-000	1/8	0.063	1.102
IN119-532-000	5/32	0.079	1.181
IN119-104-000	1/4	0.157	1.260
IN119-516-000	5/16	0.236	1.535
IN119-308-000	3/8	0.295	1.614
IN119-102-000	1/2	0.394	1.811



### IN120 Stem Adapter

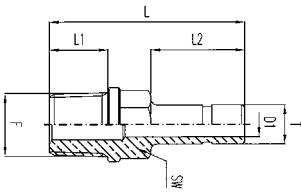

IN120	T	Thread (F)	D1	L	L1	L2	SW
IN120-108-020	1/8	1/8 NPTF	0.063	1.181	0.374	0.531	3/8
IN120-108-021	1/8	1/4 NPTF	0.063	1.358	0.512	0.531	1/2
IN120-532-020	5/32	1/8 NPTF	0.079	1.201	0.374	0.551	3/8
IN120-532-021	5/32	1/4 NPTF	0.079	1.378	0.512	0.551	1/2
IN120-104-020	1/4	1/8 NPTF	0.157	1.252	0.374	0.602	3/8
IN120-104-021	1/4	1/4 NPTF	0.157	1.429	0.512	0.602	1/2
IN120-516-020	5/16	1/8 NPTF	0.236	1.358	0.374	0.709	3/8
IN120-516-021	5/16	1/4 NPTF	0.236	1.535	0.512	0.709	1/2
IN120-308-021	3/8	1/4 NPTF	0.276	1.654	0.512	0.827	1/2
IN120-308-022	3/8	3/8 NPTF	0.276	1.673	0.512	0.827	19/32
IN120-102-022	1/2	3/8 NPTF	0.394	1.752	0.512	0.906	19/32
IN120-102-023	1/2	1/2 NPTF	0.394	1.949	0.709	0.906	11/16

### INB121 Reducer

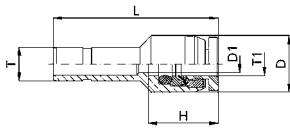

Brass Release Ring	INB121	T	T1	D	D1	L	H
INB	121-104-108	1/4	1/8	0.394	0.094	1.082	0.472
INB	121-104-532	1/4	5/32	0.394	0.118	1.142	0.492
INB	121-308-104	3/8	1/4	0.472	0.157	1.339	0.531
INB	121-102-104	1/2	1/4	0.472	0.157	1.417	0.531
INB	121-102-308	1/2	3/8	0.669	0.295	1.673	0.669

### INB122 Single Banjo

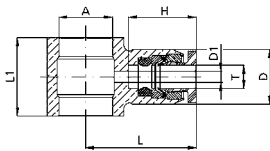

Brass Release Ring	IN122	Tube Diameter (T)	A	D	D1	L	L1	H
INB	122-532-036	5/32	10-32 UNF	0.394	0.110	0.748	0.472	0.492
INB	122-532-020	5/32	1/8 NPTF	0.394	0.118	0.795	0.571	0.492
INB	122-308-021	3/8	1/4 NPTF	0.709	0.295	1.067	0.709	0.669

### INB123 Double Banjo

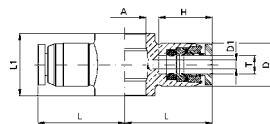

Brass Release Ring	INB123	Tube Diameter (T)	A	D	D1	L	L1	H
INB	123-532-036	5/32	10-32 UNF	0.394	0.118	0.748	0.472	0.492
INB	123-104-020	1/4	1/8 NPTF	0.472	0.157	0.811	0.571	0.531
INB	123-104-021	1/4	1/4 NPTF	0.472	0.157	0.890	0.689	0.531
INB	123-308-021	3/8	1/4 NPTF	0.709	0.295	1.067	0.709	0.669



## NPTF/Inch Tube Fittings

### IN124 Single Manifold

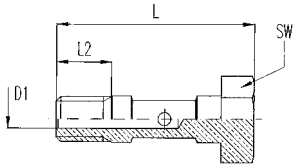

IN124	Thread (F)	L	L2	D1	SW	SW1
IN124-000-036	10-32 UNF	0.827	0.223	0.079	0.315	-
IN124-000-020	1/8 NPTF	1.634	0.374	0.197	0.551	0.551
IN124-000-021	1/4 NPTF	2.067	0.512	0.276	0.669	0.669

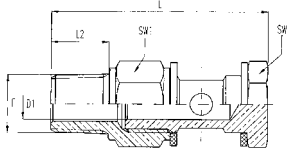

### IN125 Double Manifold

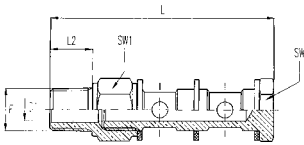

IN125	Thread (F)	L	L2	D1	SW	SW1
IN125-000-020	1/8 NPTF	2.187	0.374	0.197	0.551	0.551
IN125-000-021	1/4 NPTF	2.715	0.512	0.276	0.669	0.669

### INB131 Union Y

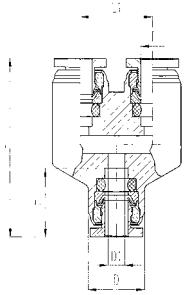

Brass Release Ring	IN131	Tube Diameter (T)	L	H	L1	D	D1
INB	131-108-000	1/8	1.240	0.472	0.512	0.394	0.094
INB	131-532-000	5/32	1.280	0.492	0.512	0.394	0.118
INB	131-104-000	1/4	1.398	0.531	0.598	0.472	0.157

### INB132 Male Y

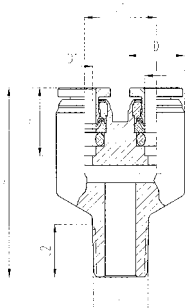

Brass Release Ring	INB132	Tube Diameter (T)	Thread (F)	L2	L	H	L1	D	D1
INB	132-108-020	1/8	1/8 NPTF	0.374	1.339	0.472	0.512	0.394	0.094
INB	132-532-020	5/32	1/8 NPTF	0.374	1.350	0.492	0.512	0.394	0.118
INB	132-104-020	1/4	1/8 NPTF	0.165	1.319	0.472	0.512	0.394	0.094



### How to Order

**NB 102 - 006 - 001**

#### Fitting Series

- \*N = Metric
- NB = Metric (Brass Release Ring)

#### Thread Size

- 100 = Union
- 101 = Bulkhead Union
- 102 = Male Connector
- 104 = Male Connector
- 105 = Female Connector w/o external box
- 106 = Union Elbow
- 108 = Swivel Elbow
- 110 = Union Tee
- 113 = Swivel Branch Tee
- 115 = Swivel Run Tee
- 117 = Union Cross
- \*118 = Plug
- \*119 = Double Male Union
- \*120 = Stem Adapter
- 121 = Reducer
- 122 = Single Banjo
- 123 = Double Banjo
- \*124 = Single Manifold
- \*125 = Double Manifold

#### Options

- (Blank) = BUNA-N O-Ring
- F = Viton "O" Ring

#### Thread Size

- 000 = 1/8 G
- 001 = 1/4 G
- 002 = 3/8 G
- 003 = 1/2 G
- 005 = M5

#### Tube Size

- 004 = 4mm
- 005 = 5mm
- 006 = 6mm
- 008 = 8mm
- 010 = 10mm
- 012 = 12mm
- 000 = No tube

\* See Fitting Style Charts on pgs 16-20 for available Tube and Thread Configurations

\*Fittings with asterisk only available in "N" Fitting Series.  
All other styles only available in "NB" Fitting Series

- Pressure Rating to 265 psi
- Temperature range: -20°F to +176°F (BUNA N O-ring)  
+230°F (Viton O-ring)
- Push-in fittings with G Threads
- Tube diameter: 4mm to 12mm
- Thread size: M5 to 1/2 G

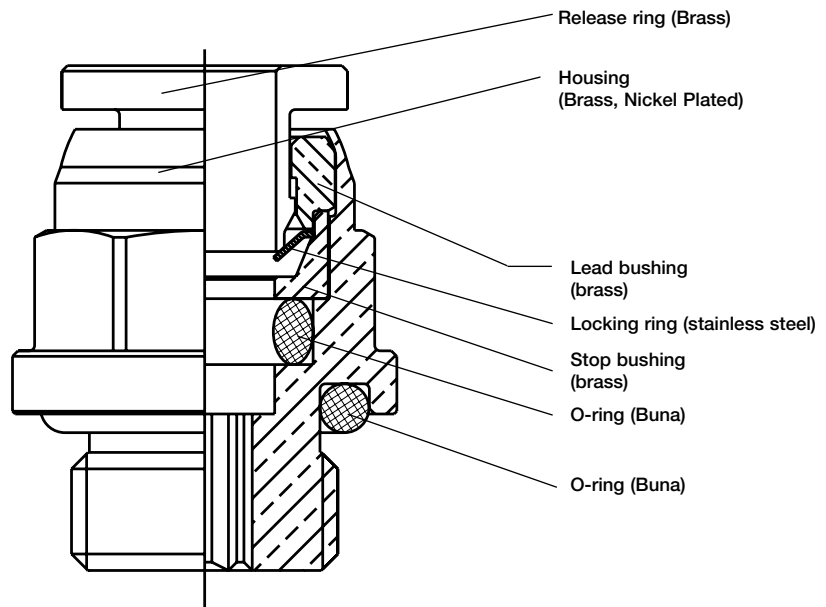

## Metric Fittings

### NB100 Union

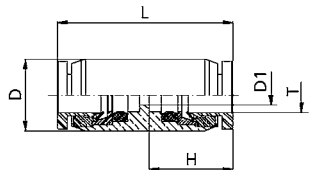

NB100	Tube Diameter (T)	D	D1	H	L
NB100-004-000	4.0	10.0	2.0	12.2	26.0
NB100-005-000	5.0	11.0	3.0	12.7	27.0
NB100-006-000	6.0	12.0	4.0	13.3	28.0
NB100-008-000	8.0	15.0	6.0	15.8	33.0
NB100-010-000	10.0	18.0	8.0	16.8	35.5
NB100-012-000	12.0	20.0	10.0	18.9	41.0

### NB101 Bulkhead Union

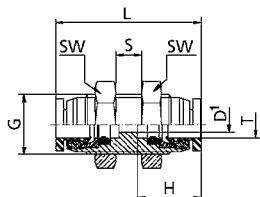

NB101	Tube Diameter (T)	External Thread (G)	D1	H	L	min. S	max. S	SW
NB101-004-000	4.0	M11	2.0	12.2	28.7	0	6	14
NB101-005-000	5.0	M12	3.0	12.7	29.2	0	6	15
NB101-006-000	6.0	M13	4.0	13.3	31.6	0	8	16
NB101-008-000	8.0	M16	6.0	15.8	36.5	0	8	19
NB101-010-000	10.0	M19	8.0	16.8	41.6	0	11	22
NB101-012-000	12.0	M22	10.0	18.9	48.0	0	15	26

### NB102 Male Connector

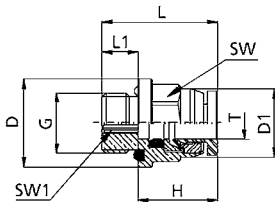

NB102	Tube Diameter (T)	Thread (G)	D	D1	H	L	L1	SW	SW1
NB102-004-000	4.0	1/8	14.0	9.9	12.2	18.1	5.7	10	3
NB102-004-001	4.0	1/4	17.0	9.9	12.2	18.8	6.0	10	3
NB102-005-000	5.0	1/8	14.0	10.9	12.7	18.8	5.7	11	3
NB102-005-001	5.0	1/4	17.0	10.9	12.7	19.2	6.0	11	3
NB102-006-000	6.0	1/8	14.0	11.9	13.3	19.0	5.7	12	4
NB102-006-001	6.0	1/4	17.0	11.9	13.3	19.8	6.0	12	4
NB102-008-000	8.0	1/8	17.0	15.0	15.8	24.5	5.7	15	6
NB102-008-001	8.0	1/4	19.0	15.0	15.8	22.0	6.0	16	6
NB102-008-002	8.0	3/8	21.0	15.0	15.8	22.7	6.5	16	6
NB102-010-001	10.0	1/4	20.0	17.4	16.8	25.3	6.0	18	7
NB102-010-002	10.0	3/8	22.0	17.4	16.8	23.3	6.5	18	7
NB102-010-003	10.0	1/2	26.0	17.4	16.8	28.3	9.5	18	7
NB102-012-001	12.0	1/4	22.0	20.0	18.9	27.4	6.0	20	7
NB102-012-002	12.0	3/8	22.0	20.0	18.9	28.0	6.0	20	7
NB102-012-003	12.0	1/2	26.0	20.0	18.9	31.5	9.5	20	9

### NB104 Male Connector without External Hex

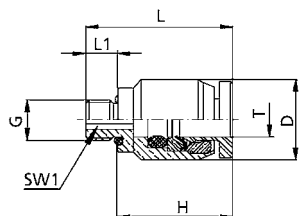

NB104	Tube Diameter (T)	Thread (G)	D	H	L	L1	SW1
NB104-004-005	4.0	M5	10.0	14.4	18.4	4.0	2
NB104-005-005	5.0	M5	11.0	14.7	18.7	4.0	2
NB104-006-005	6.0	M5	12.0	15.3	19.3	4.0	2





### NB105 Female Connector

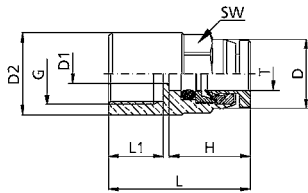

NB105	Tube Diameter (T)	Thread (G)	D	D1	D2	H	L	L1	SW
NB105-004-005	4.0	M5	9.9	2.0	8.0	12.2	19.4	5.5	10
NB105-004-000	4.0	1/8	9.9	2.0	12.0	12.2	22.4	8.5	10
NB105-005-005	5.0	M5	10.9	3.0	8.0	12.7	19.7	5.5	11
NB105-005-001	5.0	1/4	10.9	3.0	17.0	12.7	24.7	10.5	11
NB105-006-000	6.0	1/8	11.9	4.0	12.0	13.3	23.3	8.5	12
NB105-006-001	6.0	1/4	11.9	4.0	17.0	13.3	25.3	10.5	12
NB105-008-000	8.0	1/8	15.0	6.0	12.0	15.8	25.8	8.5	15
NB105-008-001	8.0	1/4	15.0	6.0	17.0	15.8	28.3	10.5	15
NB105-010-001	10.0	1/4	17.4	8.0	17.0	16.8	29.3	10.5	18
NB105-010-002	10.0	3/8	17.4	8.0	20.0	16.8	30.3	11.5	18
NB105-012-001	12.0	1/4	20.0	10.0	22.0	18.9	32.0	10.5	20
NB105-012-002	12.0	3/8	20.0	10.0	22.0	18.9	33.0	11.5	20
NB102-012-003	12.0	1/2	20.0	10.0	26.0	18.9	37.4	16.0	20

### NB106 Union Elbow

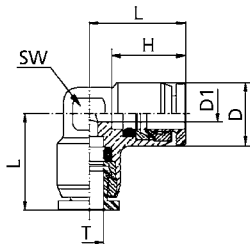

NB106	Tube Diameter (T)	D	D1	H	L	SW
NB106-004-000	4.0	9.9	2.0	12.2	16.6	9
NB106-005-000	5.0	10.9	3.0	12.7	16.6	10
NB106-006-000	6.0	11.9	4.0	13.3	19.1	11
NB106-008-000	8.0	15.0	6.0	15.8	21.8	14
NB106-010-001	10.0	17.4	8.0	16.8	25.3	16
NB106-012-000	12.0	20.4	10.0	18.9	29.1	17

### NB108 Swivel Elbow

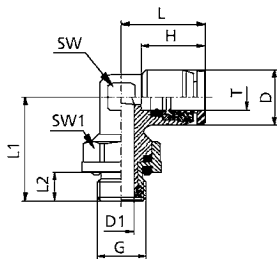

NB108	Tube Diameter (T)	Thread (G)	D	D1	H	L	L1	L2	SW	SW1
NB108-004-005	4.0	M5	9.9	2.3	12.2	16.6	16.5	4.0	9	9
NB108-004-000	4.0	1/8	9.9	4.0	12.2	16.6	19.8	5.7	9	13
NB108-004-001	4.0	1/4	9.9	4.0	12.2	16.6	20.0	6.0	9	15
NB108-005-005	5.0	M5	10.9	2.3	12.7	16.6	18.0	4.0	10	9
NB108-005-000	5.0	1/8	10.9	4.0	12.7	16.6	20.0	5.7	10	13
NB108-005-001	5.0	1/4	10.9	4.0	12.7	16.6	20.2	6.0	10	15
NB108-006-005	6.0	M5	11.9	2.3	13.3	19.1	18.5	4.0	11	9
NB108-006-000	6.0	1/8	11.9	4.0	13.3	19.1	20.9	5.7	11	13
NB108-006-001	6.0	1/4	11.9	6.0	13.3	19.1	21.0	6.0	11	15
NB108-008-000	8.0	1/8	15.0	4.0	15.8	23.3	22.7	5.7	14	13
NB108-008-001	8.0	1/4	15.0	6.0	15.8	23.3	22.7	6.0	14	15
NB108-008-002	8.0	3/8	15.0	8.0	15.8	23.3	25.2	6.5	14	18
NB108-010-000	10.0	1/8	17.4	4.0	16.8	26.5	24.0	5.7	16	13
NB108-010-001	10.0	1/4	17.4	6.0	16.8	26.5	24.1	6.0	16	15
NB108-010-002	10.0	3/8	17.4	8.0	16.8	26.5	26.4	6.5	16	18
NB108-010-003	10.0	1/2	17.4	8.0	16.8	26.5	30.4	9.5	16	18
NB108-012-001	12.0	1/4	20.0	6.0	18.9	29.1	27.3	6.0	17	15
NB108-012-002	12.0	3/8	20.0	8.0	18.9	29.1	29.5	6.5	17	18
NB108-012-003	12.0	1/2	20.0	8.0	18.9	29.1	33.5	9.5	17	18

## Metric Fittings

### NB110 Union Tee

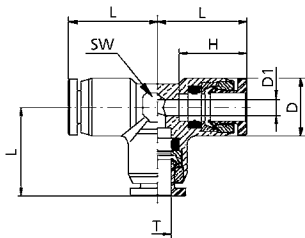

NB110	Tube Diameter (T)	D	D1	H	L	SW
NB110-004-000	4.0	9.9	2.0	12.2	16.6	9
NB110-005-000	5.0	10.9	3.0	12.7	16.6	10
NB110-006-000	6.0	11.9	4.0	13.3	19.1	11
NB110-008-000	8.0	15.0	6.0	15.8	21.8	14
NB110-010-000	10.0	17.4	8.0	16.8	25.3	16
NB110-012-000	12.0	20.4	10.0	18.9	29.1	17

### NB113 Swivel Branch Tee

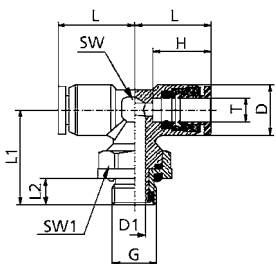

NB113	Tube Diameter (T)	Thread (G)	D	D1	H	L	L1	L2	SW	SW1
NB113-004-000	4.0	1/8	9.9	4.0	12.2	16.6	19.8	5.7	9	13
NB113-006-000	6.0	1/8	11.9	4.0	13.3	19.1	20.9	5.7	11	13
NB113-006-001	6.0	1/4	11.9	6.0	13.3	19.1	21.5	6.0	11	15
NB113-008-000	8.0	1/8	15.0	4.0	15.8	23.3	22.7	5.7	14	13
NB113-008-001	8.0	1/4	15.0	6.0	15.8	23.3	22.7	6.0	14	15
NB113-008-002	8.0	3/8	15.0	8.0	15.8	23.3	25.2	6.5	14	18
NB113-010-001	10.0	1/4	17.4	6.0	16.8	26.5	24.1	6.0	16	15
NB113-010-002	10.0	3/8	17.4	8.0	16.8	26.5	26.4	6.5	16	18
NB113-010-003	10.0	1/2	17.4	8.0	16.8	26.5	30.4	9.0	16	18
NB113-012-001	12.0	1/4	20.0	6.0	18.9	29.1	27.3	6.0	17	15
NB113-012-002	12.0	3/8	20.0	8.0	18.9	29.1	29.5	6.5	17	18
NB113-012-003	12.0	1/2	20.0	8.0	18.9	29.1	33.5	8.5	17	18

### NB115 Swivel Run Tee

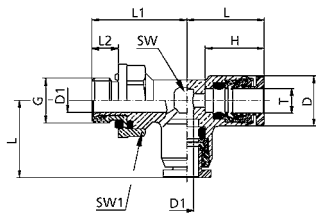

NB115	Tube Diameter (T)	Thread (G)	D	D1	H	L	L1	L2	SW	SW1
NB115-004-000	4.0	1/8	9.9	4.0	12.2	16.6	19.8	5.7	9	13
NB115-005-000	5.0	1/8	10.9	4.0	12.7	16.6	20.0	5.7	10	13
NB115-006-000	6.0	1/8	11.9	4.0	13.3	19.1	20.9	5.7	11	13
NB115-006-001	6.0	1/4	11.9	6.0	13.3	19.1	21.5	6.0	11	15
NB115-008-000	8.0	1/8	15.0	4.0	15.8	23.3	22.7	5.7	14	13
NB115-008-001	8.0	1/4	15.0	6.0	15.8	23.3	22.7	6.0	14	15
NB115-008-002	8.0	3/8	15.0	8.0	15.8	23.3	25.2	6.5	14	18
NB115-010-001	10.0	1/4	17.4	6.0	16.8	26.5	24.1	6.0	16	15
NB115-010-002	10.0	3/8	17.4	8.0	16.8	26.5	26.4	6.5	16	18
NB115-010-003	10.0	1/2	17.4	8.0	16.8	26.5	30.4	9.5	16	18
NB115-012-002	12.0	3/8	20.0	8.0	18.9	29.1	29.5	6.5	17	18
NB115-012-003	12.0	1/2	20.0	8.0	18.9	29.1	33.5	9.5	17	18

### NB117 Union Cross

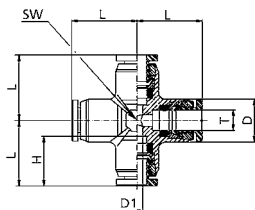

NB117	Tube Diameter (T)	D	D1	H	L	SW
NB117-004-000	4.0	9.9	2.0	12.2	16.6	9
NB117-005-000	5.0	10.9	3.0	12.7	16.6	10
NB117-006-000	6.0	11.9	4.0	13.3	19.1	11
NB117-008-000	8.0	15.0	6.0	15.8	21.8	14
NB117-010-000	10.0	17.4	8.0	16.8	25.3	16
NB117-012-000	12.0	20.4	10.0	18.9	29.1	17



### N118 Plug

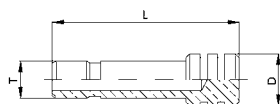

N118	Tube Diameter (T)	D	L
N118-004-000	4.0	6.0	23.1
N118-005-000	5.0	7.0	25.1
N118-006-000	6.0	8.0	25.1
N118-008-000	8.0	10.0	27.1
N118-010-000	10.0	12.0	28.1
N118-012-000	12.0	14.0	32.0

### N119 Double Male Union

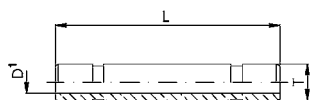

N119	Tube Diameter (T)	D	L
N119-004-000	4.0	2.0	30.0
N119-006-000	6.0	4.0	32.0
N119-008-000	8.0	6.0	38.0
N119-010-000	10.0	8.0	41.0
N119-012-000	12.0	10.0	46.0

### N120 Stem Adapter

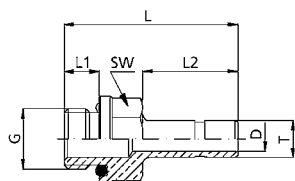

N120	Tube Diameter (T)	Thread (G)	D	L	L1	L2	SW
N120-004-005	4.0	M5	2.0	23.0	4.0	14.0	9
N120-004-000	4.0	1/8	2.0	26.7	5.7	14.0	12
N120-004-001	4.0	1/4	2.0	27.0	6.0	14.0	15
N120-005-000	5.0	1/8	3.0	27.7	5.7	15.0	12
N120-006-005	6.0	M5	2.0	24.3	4.0	15.3	9
N120-006-000	6.0	1/8	4.0	28.0	5.7	15.3	12
N120-006-001	6.0	1/4	4.0	28.3	6.0	15.3	15
N120-008-000	8.0	1/8	6.0	30.7	5.7	18.0	12
N120-008-001	8.0	1/4	6.0	31.0	6.0	18.0	15
N120-010-001	10.0	1/4	8.0	34.0	6.0	21.0	15
N120-010-002	10.0	3/8	8.0	35.0	6.5	21.0	18
N120-010-003	10.0	1/2	8.0	40.0	9.5	21.0	18
N120-012-001	12.0	1/4	10.0	36.0	6.0	23.0	15
N120-012-003	12.0	1/2	10.0	42.0	9.5	23.0	18

### NB121 Reducer

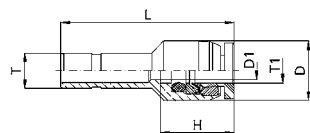

NB121	from Tube Diameter (T)	to Tube Diameter (T1)	D	D1	H	L
NB121-005-000	5.0	4.0	10.0	3.0	12.2	28.2
NB121-006-000	6.0	4.0	10.0	3.0	12.2	29.2
NB121-006-001	6.0	5.0	11.0	3.0	12.7	29.6
NB121-008-000	8.0	4.0	10.0	2.0	12.2	32.2
NB121-008-001	8.0	5.0	11.0	3.0	12.7	32.5
NB121-008-002	8.0	6.0	12.0	4.0	13.3	33.1
NB121-010-002	10.0	6.0	12.0	4.0	13.3	25.9
NB121-010-003	10.0	8.0	15.0	6.0	15.8	38.3
NB121-012-002	12.0	6.0	12.0	4.0	13.3	36.3
NB121-012-003	12.0	8.0	15.0	6.0	15.8	40.3
NB121-012-004	12.0	10.0	18.0	8.0	16.8	42.8



## Metric Fittings

### NB122 Single Banjo

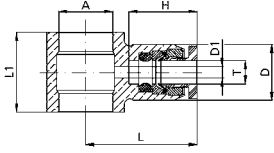

NB122	Tube Diameter (T)	for Banjo Bolts (A)	D	D1	H	L	L1
NB122-004-000	4.0	1/8	10.0	2.0	12.2	20.2	14.5
NB122-006-005	6.0	M5	12.0	4.0	13.3	20.6	12.0
NB122-006-000	6.0	1/8	12.0	4.0	13.3	20.6	14.5
NB122-006-001	6.0	1/4	12.0	4.0	13.3	22.6	14.5
NB122-008-000	8.0	1/8	15.0	6.0	15.8	23.8	17.5
NB122-008-001	8.0	1/4	15.0	6.0	15.8	25.8	17.5
NB122-010-001	10.0	1/4	17.6	8.0	16.8	27.1	18.0

### NB123 Double Banjo

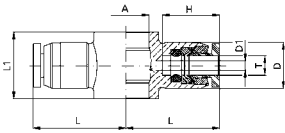

NB123	Tube Diameter (T)	for Banjo Bolts (A)	D	D1	H	L	L1
NB123-004-005	4.0	M5	10.0	2.0	12.2	19.0	12.0
NB123-004-000	4.0	1/8	10.0	2.0	12.2	20.2	14.5
NB123-006-005	6.0	M5	12.0	4.0	13.3	20.6	12.0
NB123-006-000	6.0	1/8	12.0	4.0	13.3	20.6	14.5
NB123-006-001	6.0	1/4	12.0	4.0	13.3	22.6	14.5
NB123-008-001	8.0	1/4	15.0	6.0	15.8	25.8	17.5

### N124 Single Manifold

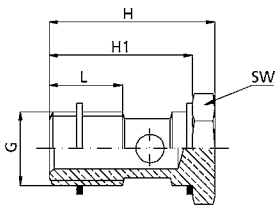

N124	Thread (F)	L	L2	D1	SW	SW1
N124-000-036	10-32 UNF	0.827	0.223	0.079	0.315	-
N124-004-000	1/8 NPTF	1.634	0.374	0.197	0.551	0.551
N124-000-001	1/4 NPTF	2.067	0.512	0.276	0.669	0.669

### N125 Double Manifold

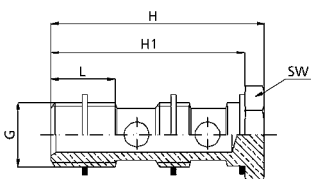

N125	Thread (G)	H	H1	L	SW
N125-000-000	1/8	43.0	39.0	8.0	14
N125-000-001	1/4	45.5	41.0	11.0	17



## NPTF Composite Fittings

### How to Order

**INP 109 – 104 – 022**

**Fitting Series**

INP = NPTF/Inch Plastic Tube

**Fitting Style**

- 100 = Union
- 103 = Male Connector
- 106 = Union Elbow
- 109 = Swivel Elbow
- 110 = Union Tee
- 114 = Swivel Branch Tee
- 116 = Swivel Run Tee
- 131 = Union Y
- 132 = Male Y

**Thread Size**

- 000 = No Thread
- 036 = 10-32 UNF
- 020 = 1/8 NPTF
- 021 = 1/4 NPTF
- 022 = 3/8 NPTF
- 023 = 1/2 NPTF

**Tube Size**

- 532 = 5/32"
- 104 = 1/4"
- 516 = 5/16"
- 308 = 3/8"
- 102 = 1/2"

\* See Fitting Style Charts on pgs 22-24 for available Tube and Thread Configurations

- Pressure Rating to 215 psi
- Vacuum Rating to 29 Inches of Mercury
- Temperature range: -20°F to +140°F
- Push-in fittings with NPTF Threads
- Teflon thread sealant
- Tube diameter: 1/8" to 1/2"
- Thread size: 10-32 UNF to 1/2 NPTF
- Body made of PBT Resin

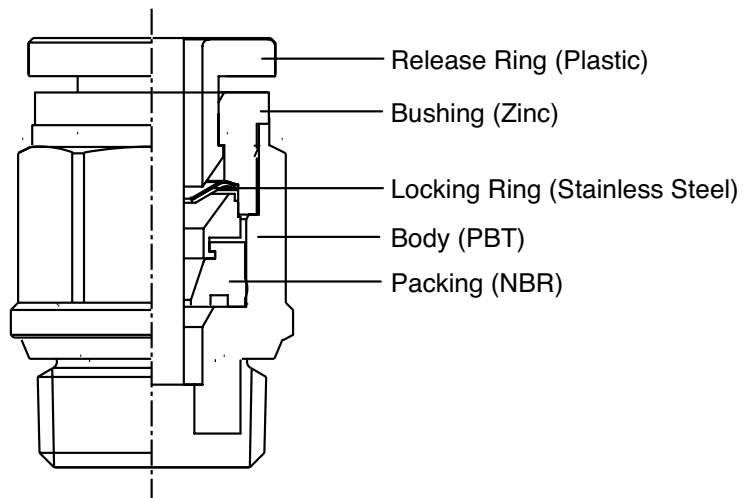



**NPTF Composite Fittings**

**INP100 Union**

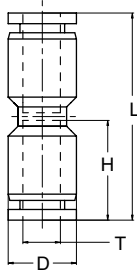

INP100	Tube Diameter (T)	D	L	H
INP100-532-000	5/32	0.433	1.197	0.555
INP100-104-000	1/4	0.528	1.358	0.624
INP100-516-000	5/16	0.583	1.500	0.713
INP100-308-000	3/8	0.724	1.843	0.823
INP100-102-000	1/2	0.854	1.874	0.870

**INP103 Male Connector**

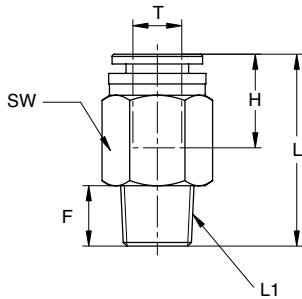

INP103	Tube Diameter (T)	Thread (F)	L	L1	H	SW
INP103-532-020	5/32	1/8 NPTF	0.795	0.315	0.516	7/16
INP103-532-021	5/32	1/4 NPTF	0.772	0.433	0.516	9/16
INP103-104-020	1/4	1/8 NPTF	0.982	0.315	0.585	1/2
INP103-104-021	1/4	1/4 NPTF	0.982	0.433	0.585	9/16
INP103-104-022	1/4	3/8 NPTF	0.904	0.472	0.585	11/16
INP103-516-020	5/16	1/8 NPTF	1.047	0.315	0.654	9/16
INP103-516-021	5/16	1/4 NPTF	1.047	0.433	0.654	9/16
INP103-308-020	3/8	1/8 NPTF	1.173	0.315	0.764	11/16
INP103-308-021	3/8	1/4 NPTF	1.311	0.433	0.764	11/16
INP103-308-022	3/8	3/8 NPTF	1.193	0.472	0.764	11/16
INP103-308-023	3/8	1/2 NPTF	1.213	0.591	0.764	7/8
INP103-102-021	1/2	1/4 NPTF	1.350	0.433	0.831	7/8
INP103-102-022	1/2	3/8 NPTF	1.390	0.472	0.831	7/8
INP103-102-023	1/2	1/2 NPTF	1.350	0.591	0.831	7/8

**INP106 Union Elbow**

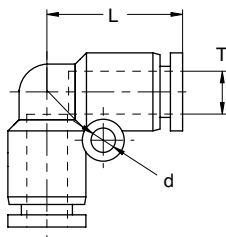

INP106	Tube Diameter (T)	L	d
INP106-532-000	5/32	0.638	-
INP106-104-000	1/4	0.766	0.126
INP106-516-000	5/16	0.878	0.126
INP106-308-000	3/8	1.067	0.165
INP106-102-000	1/2	1.154	0.169



## NPTF Composite Fittings

### INP109 Swivel Elbow

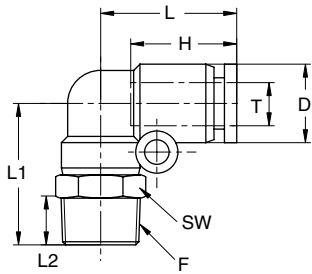

INP109	Tube Diameter (T)	Thread (F)	D	L	L1	L2	H	SW
INP109-532-036	5/32	10-32 UNF	0.433	0.638	0.669	0.157	0.535	7/16
INP109-532-020	5/32	1/8 NPTF	0.433	0.638	0.965	0.315	0.535	7/16
INP109-532-021	5/32	1/4 NPTF	0.433	0.638	1.122	0.433	0.535	9/16
INP109-104-036	1/4	10-32 UNF	0.528	0.766	0.689	0.157	0.624	1/2
INP109-104-020	1/4	1/8 NPTF	0.528	0.766	1.063	0.315	0.624	1/2
INP109-104-021	1/4	1/4 NPTF	0.528	0.766	1.201	0.433	0.624	9/16
INP109-104-022	1/4	3/8 NPTF	0.528	0.766	1.260	0.472	0.624	11/16
INP109-516-020	5/16	1/8 NPTF	0.583	0.878	1.181	0.315	0.713	9/16
INP109-516-021	5/16	1/4 NPTF	0.583	0.878	1.299	0.433	0.713	9/16
INP109-308-020	3/8	1/8 NPTF	0.724	1.067	1.370	0.315	0.803	11/16
INP109-308-021	3/8	1/4 NPTF	0.724	1.067	1.488	0.433	0.803	11/16
INP109-308-022	3/8	3/8 NPTF	0.724	1.067	1.528	0.472	0.803	11/16
INP109-308-023	3/8	1/2 NPTF	0.724	1.067	1.665	0.591	0.803	7/8
INP109-102-021	1/2	1/4 NPTF	0.854	1.154	1.594	0.433	0.870	7/8
INP109-102-022	1/2	3/8 NPTF	0.854	1.154	1.634	0.472	0.870	7/8
INP109-102-023	1/2	1/2 NPTF	0.854	1.154	1.752	0.591	0.870	7/8

### INP110 Union Tee

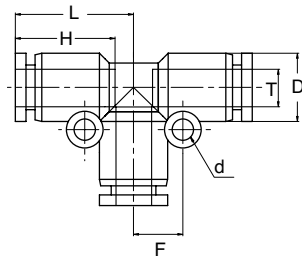

INP110	Tube Diameter (T)	D	L	H	F	d
INP110-532-000	5/32	0.433	0.677	0.555	0.276	0.126
INP110-104-000	1/4	0.528	0.774	0.624	0.327	0.126
INP110-516-000	5/16	0.583	0.876	0.693	0.354	0.126
INP110-308-000	3/8	0.724	1.094	0.823	0.472	0.165
INP110-102-000	1/2	0.854	1.154	0.870	0.543	0.169

### INP114 Swivel Branch Tee

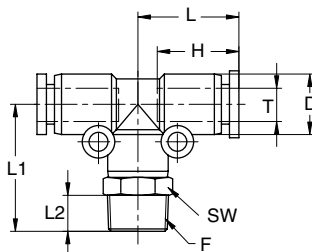

INP114	Tube Diameter (T)	Thread (F)	D	L	L1	L2	H	SW
INP114-532-036	5/32	10-32 UNF	0.433	0.638	0.886	0.157	0.535	7/16
INP114-532-020	5/32	1/8 NPTF	0.433	0.638	0.965	0.315	0.535	7/16
INP114-532-021	5/32	1/4 NPTF	0.433	0.638	1.122	0.433	0.535	9/16
INP114-104-036	1/4	10-32 UNF	0.528	0.766	0.925	0.157	0.624	1/2
INP114-104-020	1/4	1/8 NPTF	0.528	0.766	1.063	0.315	0.624	1/2
INP114-104-021	1/4	1/4 NPTF	0.528	0.766	1.201	0.433	0.624	9/16
INP114-104-022	1/4	3/8 NPTF	0.528	0.766	1.260	0.472	0.624	11/16
INP114-516-020	5/16	1/8 NPTF	0.583	0.878	1.181	0.315	0.713	9/16
INP114-516-021	5/16	1/4 NPTF	0.583	0.878	1.299	0.433	0.713	9/16
INP114-308-021	3/8	1/4 NPTF	0.724	1.067	1.488	0.433	0.803	11/16
INP114-308-022	3/8	3/8 NPTF	0.724	1.067	1.528	0.472	0.803	11/16
INP114-308-023	3/8	1/2 NPTF	0.724	1.067	1.665	0.591	0.803	7/8
INP114-102-021	1/2	1/4 NPTF	0.854	1.154	1.594	0.433	0.870	7/8
INP114-102-022	1/2	3/8 NPTF	0.854	1.154	1.634	0.472	0.870	7/8
INP114-102-023	1/2	1/2 NPTF	0.854	1.154	1.752	0.591	0.870	7/8



**NPTF Composite Fittings**

**INP116 Swivel Run Tee**

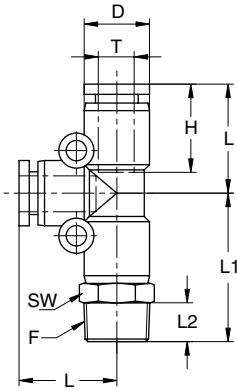

INP116	Tube Diameter (T)	Thread (F)	D	L	L1	L2	H	SW
INP116-532-036	5/32	10-32 UNF	0.433	0.638	0.886	0.157	0.535	7/16
INP116-532-020	5/32	1/8 NPTF	0.433	0.638	0.965	0.315	0.535	7/16
INP116-532-021	5/32	1/4 NPTF	0.433	0.638	1.122	0.433	0.535	9/16
INP116-104-036	1/4	10-32 UNF	0.528	0.766	0.925	0.157	0.624	1/2
INP116-104-020	1/4	1/8 NPTF	0.528	0.766	1.063	0.315	0.624	1/2
INP116-104-021	1/4	1/4 NPTF	0.528	0.766	1.201	0.433	0.624	9/16
INP116-104-022	1/4	3/8 NPTF	0.528	0.766	1.260	0.472	0.624	11/16
INP116-516-020	5/16	1/8 NPTF	0.583	0.878	1.181	0.315	0.713	9/16
INP116-516-021	5/16	1/4 NPTF	0.583	0.878	1.299	0.433	0.713	9/16
INP116-308-021	3/8	1/4 NPTF	0.724	1.067	1.488	0.433	0.803	11/16
INP116-308-022	3/8	3/8 NPTF	0.724	1.067	1.528	0.472	0.803	11/16
INP116-308-023	3/8	1/2 NPTF	0.724	1.067	1.665	0.591	0.803	7/8
INP116-102-021	1/2	1/4 NPTF	0.854	1.154	1.594	0.433	0.870	7/8
INP116-102-022	1/2	3/8 NPTF	0.854	1.154	1.634	0.472	0.870	7/8
INP116-102-023	1/2	1/2 NPTF	0.854	1.154	1.752	0.591	0.870	7/8

**INP131 Union Y**

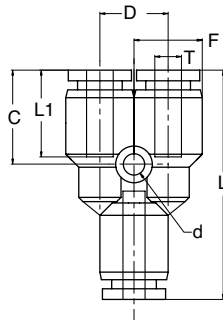

INP131	Tube Diameter (T)	D	L	L1	C	F	d
INP131-532-000	5/32	0.433	1.295	0.433	0.535	0.394	0.126
INP131-104-000	1/4	0.528	1.433	0.528	0.604	0.413	0.126
INP131-516-000	5/16	0.583	1.551	0.591	0.673	0.528	0.126
INP131-308-000	3/8	0.724	1.917	0.709	0.783	0.610	0.165
INP131-102-000	1/2	0.854	2.051	0.846	0.870	0.630	0.165

**INP132 Male Y**

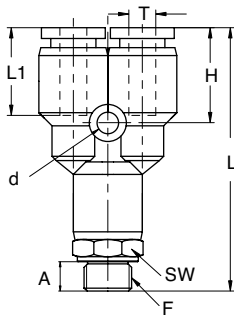

INP132	Tube Diameter (T)	Thread (F)	L	L1	A	H	d	SW
INP132-532-020	5/32	1/8 NPTF	1.622	0.433	0.394	0.535	0.126	7/16
INP132-532-021	5/32	1/4 NPTF	1.780	0.433	0.394	0.535	0.126	9/16
INP132-104-020	1/4	1/8 NPTF	1.732	0.528	0.413	0.604	0.126	1/2
INP132-104-021	1/4	1/4 NPTF	1.870	0.528	0.413	0.604	0.126	9/16
INP132-516-020	5/16	1/8 NPTF	1.854	0.591	0.528	0.673	0.126	9/16
INP132-516-021	5/16	1/4 NPTF	1.972	0.591	0.528	0.673	0.126	9/16
INP132-308-021	3/8	1/4 NPTF	2.339	0.709	0.610	0.783	0.165	11/16
INP132-308-022	3/8	3/8 NPTF	2.378	0.709	0.610	0.783	0.165	11/16
INP132-102-022	1/2	3/8 NPTF	2.531	0.846	0.630	0.870	0.165	7/8





## Composite Metric Fittings

### How to Order

**NP 109 – 104 – 022**

**Fitting Series**

NP = Metric Plastic Fittings

**Fitting Style**

- 100 = Union
- 102 = Male Connector
- 106 = Union Elbow
- 108 = Swivel Elbow
- 110 = Union Tee
- 113 = Swivel Branch Tee
- 115 = Swivel Run Tee
- 131 = Union Y
- 132 = Male Y

**Thread Size**

- 000 = 1/8 G
- 001 = 1/4 G
- 002 = 3/8 G
- 003 = 1/2 G
- 005 = M5

**Tube Size**

- 004 = 4mm
- 006 = 6mm
- 008 = 8mm
- 010 = 10mm
- 012 = 12mm

\* See Fitting Style Charts on pgs 26-27 for available Tube and Thread Configurations

- Pressure Rating to 215 psi
- Vacuum Rating to 29 Inches of Mercury
- Temperature range: -20°F to +140°F
- Push-in fittings with G Threads
- Tube diameter: 4mm to 12mm
- Thread size: M5 to 1/2 G
- Body made of PBT Resin

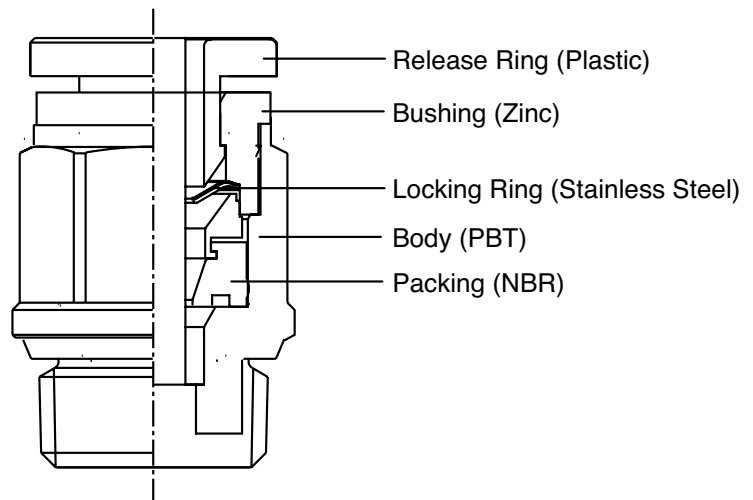



## Composite Metric Fittings

### NP100 Union

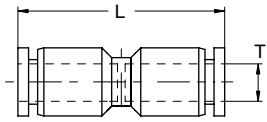

NP100	Tube Diameter (T)	L
NP100-004-000	4.0	33.0
NP100-006-000	6.0	35.2
NP100-008-000	8.0	39.1
NP100-010-000	10.0	47.8
NP100-012-000	12.0	49.2

### NP102 All-Composite Straight Connector

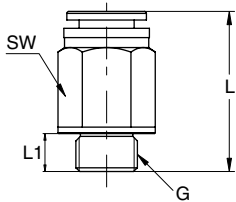

NP102	Tube Diameter (T)	Thread (G)	L	L1	SW
NP102-006-000	6.0	1/8	25.0	5.5	12
NP102-006-001	6.0	1/4	24.0	7.5	14
NP102-008-000	8.0	1/8	26.6	5.5	14
NP102-008-001	8.0	1/4	25.6	7.5	14
NP102-008-002	8.0	3/8	23.8	8.5	17
NP102-010-001	10.0	1/4	33.3	7.5	17
NP102-010-002	10.0	3/8	29.8	8.5	17
NP102-010-003	10.0	1/2	30.8	11.0	21
NP102-012-002	12.0	3/8	30.6	8.5	21
NP102-012-003	12.0	1/2	33.6	11.0	21

### NP106 Union Elbow

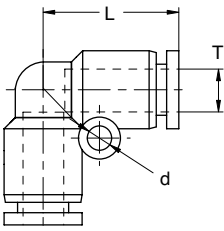

NP106	Tube Diameter (T)	L	d
NP106-004-000	4.0	17.5	-
NP106-006-000	6.0	19.0	3.2
NP106-008-000	8.0	22.8	3.2
NP106-010-000	10.0	27.6	4.2
NP106-012-000	12.0	29.6	4.3



### NP108 Swivel Elbow

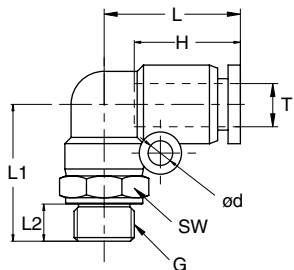

NP108	Tube Diameter (T)	Thread (G)	H	L	L1	L2	SW
NP108-004-005	4.0	M5	15.1	17.5	17.0	4.0	10
NP108-004-000	4.0	1/8	15.1	17.7	24.5	5.5	14
NP108-004-001	4.0	1/4	15.1	17.7	27.0	7.5	17
NP108-006-005	6.0	M5	16.0	19.0	17.5	4.0	12
NP108-006-000	6.0	1/8	16.0	19.3	25.7	5.5	14
NP108-006-001	6.0	1/4	16.0	19.3	28.2	7.5	17
NP108-006-002	6.0	3/8	16.0	19.3	29.7	8.5	20
NP108-008-000	8.0	1/8	18.1	22.8	29.0	5.5	14
NP108-008-001	8.0	1/4	18.1	22.8	31.5	7.5	17
NP108-008-002	8.0	3/8	18.1	22.8	33.0	8.5	20
NP108-010-000	10.0	1/8	20.4	27.6	33.8	5.5	17
NP108-010-001	10.0	1/4	20.4	27.6	35.8	7.5	17
NP108-010-002	10.0	3/8	20.4	27.6	37.3	8.5	20
NP108-010-003	10.0	1/2	20.4	27.6	41.3	11.0	24
NP108-012-001	12.0	1/4	23.2	29.6	38.0	7.5	21
NP108-012-002	12.0	3/8	23.2	29.6	39.0	8.5	21
NP108-012-003	12.0	1/2	23.2	29.6	43.0	11.0	24

### NP110 Union Tee

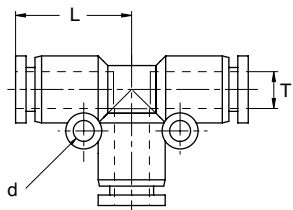

NP110	Tube Diameter (T)	L	d
NP110-004-000	4.0	18.5	3.2
NP110-006-000	6.0	19.3	3.2
NP110-008-000	8.0	22.75	3.2
NP110-010-000	10.0	28.3	4.2
NP110-012-000	12.0	29.6	4.3

### NP113 Swivel Branch Tee

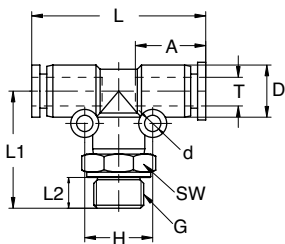

NP113	Tube Diameter (T)	Thread (G)	D	A	H	L	L1	L2	d	SW
NP113-004-005	4.0	M5	11.0	14.0	15.1	37.4	22.5	4.0	3.2	10
NP113-004-000	4.0	1/8	11.0	14.0	15.1	37.4	25.5	5.5	3.2	14
NP113-006-005	6.0	M5	13.0	16.0	16.0	39.2	23.5	4.0	3.2	12
NP113-006-000	6.0	1/8	13.0	16.0	16.0	39.2	26.0	5.5	3.2	14
NP113-006-001	6.0	1/4	13.0	16.0	16.0	39.2	28.5	7.5	3.2	17
NP113-008-000	8.0	1/8	14.8	18.0	18.1	45.5	29.0	29.0	3.2	14
NP113-008-001	8.0	1/4	14.8	18.0	18.1	45.5	31.5	31.5	3.2	17
NP113-008-002	8.0	3/8	14.8	18.0	18.1	45.5	33.0	33.0	3.2	20
NP113-010-001	10.0	1/4	18.4	24.0	20.4	56.3	36.5	36.5	4.2	17
NP113-010-002	10.0	3/8	18.4	24.0	20.4	56.3	38.0	38.0	4.2	20
NP113-010-003	10.0	1/2	18.4	24.0	20.4	56.3	42.0	42.0	4.2	24
NP113-012-001	12.0	1/4	21.0	27.0	23.2	59.2	38.0	38.0	4.2	21
NP113-012-002	12.0	3/8	21.0	27.0	23.2	59.2	39.0	39.0	4.2	21
NP113-012-003	12.0	1/2	21.0	27.0	23.2	59.2	43.0	43.0	4.2	24



**World Thread Flow Controls**

**INWB1391C World Thread Flow Control – Inch Tube**

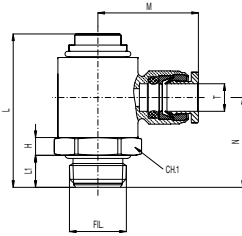

Brass Release Ring	INWB1391C	Tube Diameter (T)	Thread (F)	L	M	N	L1	CH.1	H
INB	1391C-108-020	1/8	1/8	42.4	20.5	24.0	4.9	14	6
INB	<b>1391C-532-020</b>	5/32	1/8	42.4	21.0	24.0	4.9	14	6
INB	1391C-104-020	1/4	1/8	42.4	21.5	24.0	4.9	14	6
INB	1391C-104-021	1/4	1/4	37.5	23.0	23.2	7.2	17	7
INB	1391C-516-021	5/16	1/4	37.5	26.0	23.2	7.2	17	7
INB	1391C-308-021	3/8	1/4	37.5	27.5	23.2	7.2	17	7
INB	1391C-516-022	5/16	3/8	42.2	28.0	26.0	7.6	20	8
INB	1391C-308-022	3/8	3/8	42.2	29.5	26.0	7.6	20	8

**INWB139C World Thread Flow Control with Knob – Inch Tube**

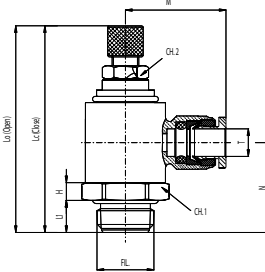

Brass Release Ring	INWB139C	Tube Diameter (T)	Thread (F)	Lc	Lo	M	N	L1	CH.1	H	CH.2
INB	139C-108-020	1/8	1/8	54.5	61.0	20.5	24.0	4.9	14	6	7
INB	139C-532-020	5/32	1/8	54.5	61.0	21.0	24.0	4.9	14	6	7
INB	139C-104-020	1/4	1/8	54.5	61.0	21.5	24.0	4.9	14	6	7
INB	139C-104-021	1/4	1/4	50.0	54.5	23.0	23.2	7.2	17	7	9
INB	139C-516-021	5/16	1/4	50.0	54.5	26.0	23.2	7.2	17	7	9
INB	139C-308-021	3/8	1/4	50.0	54.5	27.5	23.2	7.2	17	7	9
INB	139C-516-022	5/16	3/8	56.8	60.3	28.0	26.0	7.6	20	8	11
INB	139C-308-022	3/8	3/8	56.8	60.3	29.5	26.0	7.6	20	8	11

**NWB1391C World Thread Flow Control – Metric Tube**

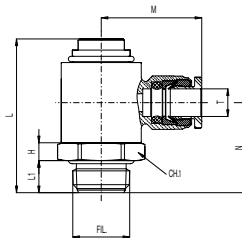

NWB1391C	Tube Diameter (T)	Thread (F)	L	M	N	L1	CH.1	H
NWB1391C-004-020	4mm	1/8	42.4	20.5	24.0	4.9	14	6
NWB1391C-006-020	6mm	1/8	42.4	21.0	24.0	4.9	14	6
NWB1391C-006-021	6mm	1/4	37.5	23.0	23.2	7.2	17	7
NWB1391C-008-021	8mm	1/4	37.5	26.5	23.2	7.2	17	7
NWB1391C-010-021	10mm	1/4	37.5	27.5	23.2	7.2	17	7
NWB1391C-008-022	8mm	3/8	42.2	28.0	26.0	7.6	20	8
NWB1391C-010-022	10mm	3/8	42.2	29.5	26.0	7.6	20	8

**NWB139C World Thread Flow Control with Knob – Metric Tube**

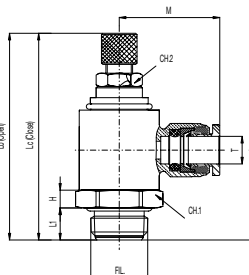

NWB139C	Tube Diameter (T)	Thread (F)	Lc	Lo	M	N	L1	CH.1	H	CH.2
NWB139C-004-020	4mm	1/8	54.5	61.0	20.5	24.0	4.9	14	6	7
NWB139C-006-020	6mm	1/8	54.5	61.0	21.0	24.0	4.9	14	6	7
NWB139C-006-021	6mm	1/4	50.0	54.5	23.0	23.2	7.2	17	7	9
NWB139C-008-021	8mm	1/4	50.0	54.5	26.5	23.2	7.2	17	7	9
NWB139C-010-021	10mm	1/4	50.0	54.5	27.5	23.2	7.2	17	7	9
NWB139C-008-022	8mm	3/8	56.8	60.3	28.0	26.0	7.6	20	8	11
NWB139C-010-022	10mm	3/8	56.8	60.3	29.5	26.0	7.6	20	8	11



### OEM Flow Controls

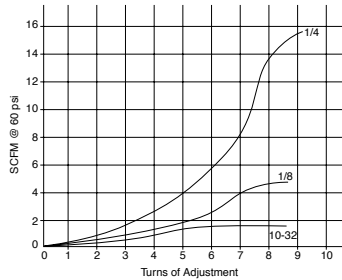
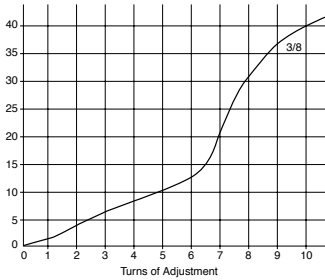

#### Features

Knob adjust, screwdriver adjust

#### Specifications

Temperature Range: 0° to 176°F

Maximum Operating Pressure: 265 psi

#### Materials of Construction

Body: brass-nickel plated; screw: stainless steel; seals: Buna; release button: oil or brass; adjustment needle: brass

### INB135C Flow control

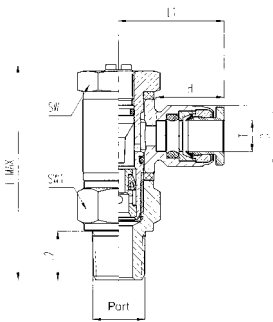

Brass Release Ring	135C	Tube Diameter (T)	PORTS NPTF	L MAX	L1	L2	H	D	DIMENS	
									SW	SW1
INB	135C-108-036	1/8	10-32	.945	0.748	0.217	0.472	0.394	0.315	/
INB	135C-108-020	1/8	1/8	1.665	0.748	0.374	0.472	0.394	0.551	0.551
INB	135C-532-036	5/32	10-32	.945	0.748	0.217	0.492	0.394	0.315	/
INB	135C-532-020	5/32	1/8	1.673	0.795	0.374	0.492	0.394	0.551	0.551
INB	135C-104-020	1/4	1/8	1.673	0.881	0.374	0.531	0.472	0.551	0.551
INB	135C-104-021	1/4	1/4	2.126	0.890	0.512	0.531	0.472	0.669	0.669
INB	135C-308-021	3/8	1/4	2.126	1.067	0.512	0.669	0.709	0.669	0.669
INB	135C-308-022	3/8	3/8	2.333	1.220	0.512	0.669	0.709	0.748	0.866

### INB136C Flow Control with Knob

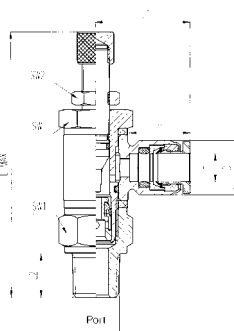

Brass Release Ring	136C	Tube Diameter (T)	PORTS NPTF	L MAX	L1	L2	H	D	DIMENS	
									SW	SW1
INB	136C-108-036	1/8	10-32	.945	0.748	0.217	0.472	0.394	0.315	/
INB	136C-108-020	1/8	1/8	1.665	0.748	0.374	0.472	0.394	0.551	0.551
INB	136C-532-036	5/32	10-32	.945	0.748	0.217	0.492	0.394	0.315	/
INB	136C-532-020	5/32	1/8	1.673	0.795	0.374	0.492	0.394	0.551	0.551
INB	136C-104-020	1/4	1/8	1.673	0.881	0.374	0.531	0.472	0.551	0.551
INB	136C-104-021	1/4	1/4	2.126	0.890	0.512	0.531	0.472	0.669	0.669
INB	136C-308-021	3/8	1/4	2.126	1.067	0.512	0.669	0.709	0.669	0.669
INB	136C-308-022	3/8	3/8	2.333	1.220	0.512	0.669	0.709	0.748	0.866



**Valves and Flow Controls**

**INP136C Composite Tube Flow Control with Knob**

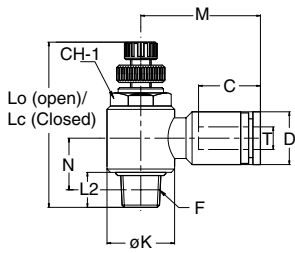

INP136C	Tube Diameter (T)	Thread (F)	D	Lc	Lo	M	N	L1	C	K	CH.1
INP136C-532-036	5/32	10-32 UNF	0.433	1.220	1.449	1.063	0.413	0.157	0.535	0.567	7/16
INP136C-532-020	5/32	1/8 NPTF	0.433	1.378	1.606	1.063	0.413	0.315	0.535	0.567	7/16
INP136C-104-036	1/4	10-32 UNF	0.528	1.220	1.449	0.896	0.421	0.157	0.604	0.567	1/2
INP136C-104-020	1/4	1/8 NPTF	0.528	1.378	1.606	0.896	0.421	0.315	0.604	0.567	7/16
INP136C-104-021	1/4	1/4 NPTF	0.528	1.646	1.890	0.976	0.461	0.433	0.604	0.720	9/16
INP136C-516-020	5/16	1/8 NPTF	0.583	1.378	1.606	0.988	0.445	0.315	0.713	0.567	7/16
INP136C-516-021	5/16	1/4 NPTF	0.583	1.646	1.890	1.108	0.492	0.433	0.713	0.720	9/16
INP136C-308-021	3/8	1/4 NPTF	0.724	1.646	1.890	1.254	0.559	0.433	0.803	0.720	9/16
INP136C-308-022	3/8	3/8 NPTF	0.724	1.870	2.106	1.236	0.583	0.472	0.803	0.866	3/4
INP136C-102-022	1/2	3/8 NPTF	0.854	1.870	2.106	1.402	0.648	0.472	0.870	0.866	3/4
INP136C-102-023	1/2	1/2 NPTF	0.854	2.047	2.283	1.476	0.695	0.591	0.870	1.102	1

**NP136C Composite Flow Control with Knob**

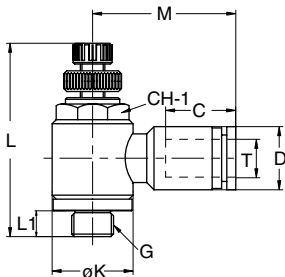

NP136C	Tube Diameter (T)	Thread	D	L	M	L1	C	K	CH.1
NP136C-004-005	4.0	M5	10.0	28.2	20.0	4.0	15.1	14.4	8
NP136C-004-000	4.0	1/8	10.0	41.1	22.5	5.7	15.1	14.4	14
NP136C-006-005	6.0	M5	12.0	28.2	21.9	5.700	16.0	14.4	14
NP136C-006-000	6.0	1/8	12.0	41.1	23.4	5.7	16.0	14.4	14
NP136C-006-001	6.0	1/4	12.0	48.8	25.5	8.3	16.0	18.3	17
NP136C-008-000	8.0	1/8	14.0	41.1	25.6	5.7	18.1	14.4	14
NP136C-008-001	8.0	1/4	14.0	48.8	28.7	8.3	18.1	18.3	17
NP136C-010-001	10.0	1/4	17.0	48.8	32.3	8.3	20.4	18.3	17
NP136C-010-002	10.0	3/8	17.0	54.5	32.9	13.9	20.4	22.0	21
NP136C-012-002	12.0	3/8	20.0	54.5	35.6	13.9	23.2	22.0	21
NP136C-012-003	12.0	1/2	20.0	60.0	36.6	11.0	23.2	28.0	24

**INP139 Composite Inline Flow Control with Knob - Inch Tube**

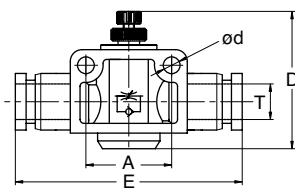

INP139	Tube Diameter (T)	D	A	E	d
INP139C-532-000	5/32	25.7	14.0	39.5	3.2
INP139C-104-000	1/4	41.9	20.0	47.3	4.3
INP139C-516-000	5/16	45.6	22.0	52.6	4.3
INP139C-308-000	3/8	52.3	26.0	62.9	4.3
INP139C-102-000	1/2	55.0	32.0	73.7	4.3

**NP139 Composite Inline Flow Control with Knob - Metric Tube**

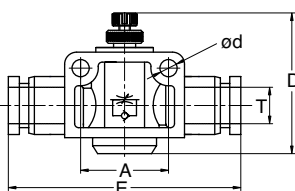

NP139	Tube Diameter (T)	D	A	E	d
NP139C-004-000	4 mm	25.7	14.0	39.5	3.2
NP139C-006-000	6 mm	41.9	20.0	47.6	4.3
NP139C-008-000	8 mm	45.6	22.0	52.6	4.3
NP139C-010-000	10 mm	52.3	26.0	63.1	4.3
NP139C-012-000	12 mm	55.0	32.0	74.2	4.3



### Flow Controls

#### Features

Body swivels 360°, provides accurate speed control in a compact size and eliminates need for fitting.

#### Specifications

Temperature Range: 0° to 160° F

Maximum Operating Pressure: 175 PSIG (12 bar)

#### Materials of Construction

Body: anodized aluminum; cartridge: nickel plated brass; screw: stainless steel; spring: stainless steel; seals: Buna N

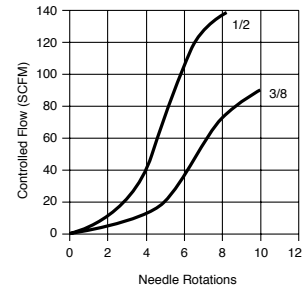
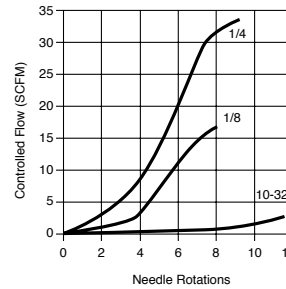

### Standard Flow Control (with and without push-in fitting)

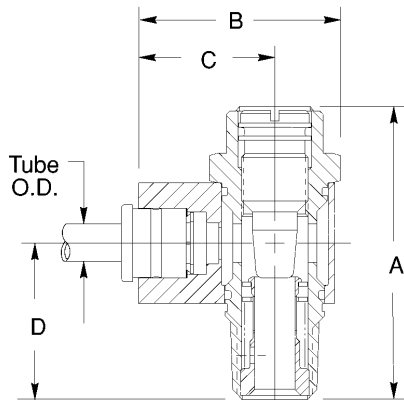

Ports NPTF	Without Push-In	With Push-In	Tube Diameter (T)	DIMENSIONS			
				A	B	C	D
10-32	0FCRN	0FPRN4 0FPRN5	1/8 5/32	.89	.62	.43	.69
1/8	1FCRN	1FPRN8 1FPRN5	1/4 5/32	1.46	.98	.65	1.00
1/4	2FCRN	2FPRN8 2FPRN12	1/4 3/8	1.78	1.28	.91	1.03
3/8	3FCRN	3FPRN12 3FPRN16	3/8 1/2	2.23	1.45	1.02	1.30
1/2	4FCRN	4FPRN12 4FPRN16	3/8 1/2	2.82	1.84	1.28	1.40

### Knob Adjust Flow Control (with and without push-in fitting)

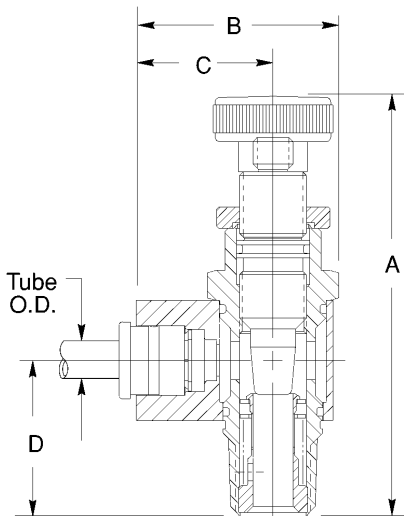

Ports NPTF	Without Push-In	With Push-In	Tube Diameter (T)	DIMENSIONS			
				A	B	C	D
10-32	0FCTN	0FPTN4 0FPTN5	1/8 5/32	1.21	.62	.43	.69
1/8	1FCTN	1FPTN8 1FPTN5	1/4 5/32	2.21	.98	.65	1.00
1/4	2FCTN	2FPTN8 2FPTN12	1/4 3/8	2.50	1.28	.91	1.03
3/8	3FCTN	3FPTN12 3FPTN16	3/8 1/2	3.23	1.45	1.02	1.30
1/2	4FCTN	4FPTN12 4FPTN16	3/8 1/2	3.96	1.84	1.28	1.40

### Metric Flow Controls

#### How to Order

Change "N" to "G" in part number for BSPP Thread or Tube option.

For example, change 0FCTN to 0FCTG or change 0FPTN4 to 0FPTG4.



## Valves and Flow Controls

### 1FC1 Inline Flow controls

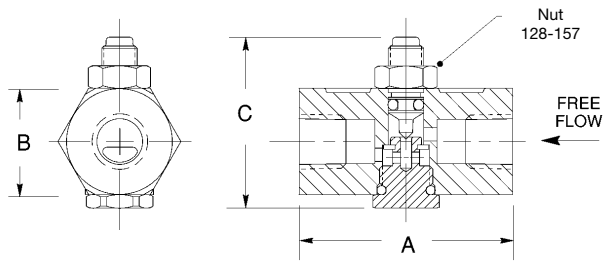

Ports NPTF	Without Knurled Knob	With Knurled Knob	Cv	DIMENSIONS			
				A	B	C	D
1/8	1FC1	1FC1K	.22	1.50	.75	1.08	1.66
1/4	2FC1	2FC1K	.22	1.50	.75	1.08	1.66

#### Optional Knurled Knob (suffix K)

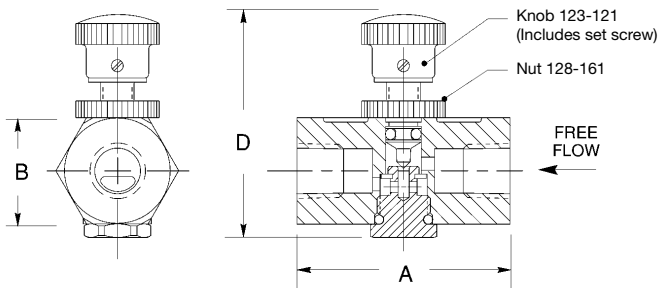

### FC2 Inline Flow Controls

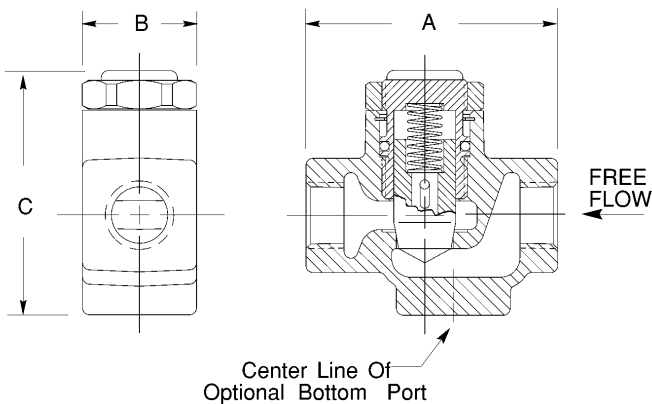

Ports NPTF	Without Bottom Port	With Bottom Port	Cv	DIMENSIONS		
				A	B	C
1/4	2FC2	2FC2B	2.3	2.34	1.06	2.21
3/8	3FC2	3FC2B	2.7	2.34	1.06	2.21

Ports NPTF	Without Bottom Port	With Bottom Port	Cv	DIMENSIONS		
				A	B	C
1/2	4FC3	4FC3B	6.0	3.28	1.50	3.17
3/4	5FC3	5FC3B	7.5	3.28	1.50	3.17





### Pilot Operated Check Valves

- NPTF threads have thread sealant applied
- Temperature range: 15°F to 160°F
- Operating pressure range: 15 psi to 150 psi

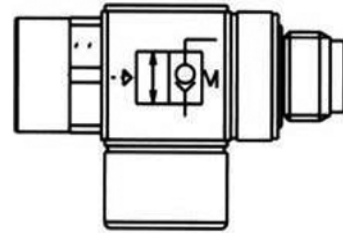
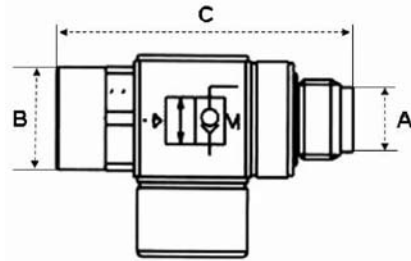

Part Number	A	B	C	Max Tightening Torque		D	Pilot Port
NCPGG-020-020	1/8" NPTF	SW13	1.164	7 Nm	5.1 lbs/ft	1/8" NPTF	10-32 UNF
NCPGG-021-021	1/4" NPTF	SW17	1.890	15 Nm	11.0 lbs/ft	1/4" NPTF	10-32 UNF
NCPGG-022-022	3/8" NPTF	SW22	2.165	20 Nm	14.7 lbs/ft	3/8" NPTF	1/8" NPTF
NCPGG-023-023	1/2" NPTF	SW27	2.579	20 Nm	14.7 lbs/ft	1/2" NPTF	1/8" NPTF

### Flow Characteristics

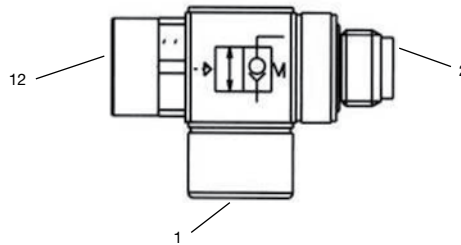

Minimum signal pressure  $p_{12}$  to open the valve

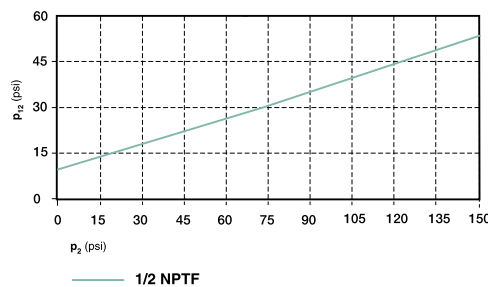
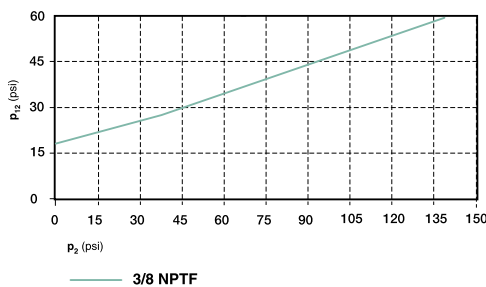
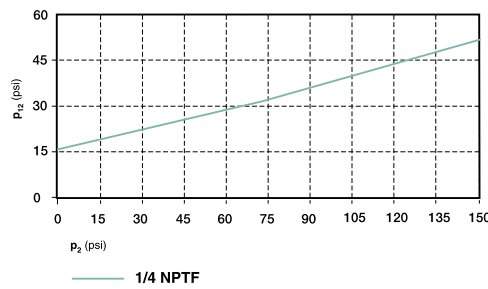
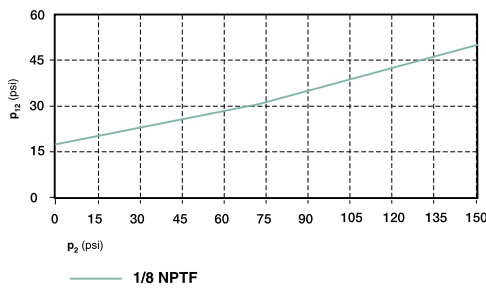



## Quick Exhaust, Slide and Shuttle Valves

### SEV Quick Exhaust Valve

#### Specifications

Quick exhaust valve, line mounting

Temperature Range: -40° to 165° F

Pressure range: 3.9 to 145 PSI

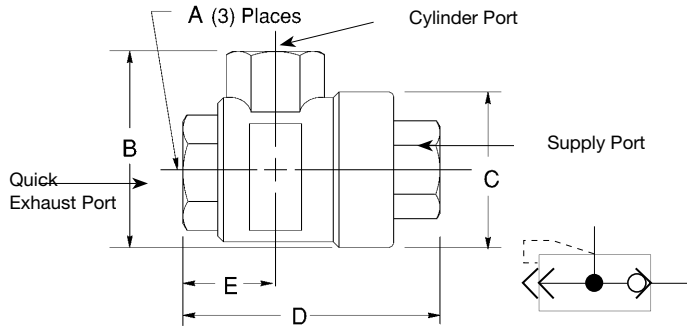

Ports NPTF	SEV_BN	DIMENSIONS				
		A	B	C	D	E
1/8	SEV10BN	1/8	1.30	1.10	1.65	0.55
1/4	SEV25BN	1/4	1.58	1.30	2.05	0.71
3/8	SEV38BN	3/8	1.70	1.30	2.16	0.75
1/2	SEV50BN	1/2	2.17	1.69	2.80	1.06
3/4	SEV75BN	3/4	2.45	1.93	3.55	1.42

Ports G Tap	SEV_	DIMENSIONS				
		A	B	C	D	E
1/8	SEV10B	G1/8	33	28	42	14
1/4	SEV25B	G1/4	40	33	52	18
1/2	SEV50B	G1/2	55	43	71	27
3/4	SEV75B	G3/4	74	64	90	42
1	SEV100B	G1	88	80	108	48

NOTE: Service parts are available, please consult the factory.

### IN530 Slide Valve

#### Features

The IN530 Slide Valve allows easy isolation of downstream components by dumping circuit pressure.

#### Specifications

Temperature Range: 0° to 160° F

Maximum Operating Pressure: 150 PSIG (10 bar)

Pipe Sizes: 1/8, 1/4, 3/8 1/2 NPTF

#### Materials of Construction

Sleeve: Aluminum

Body: Chrome Plated Brass

Seal: Buna

Snap Ring: Steel

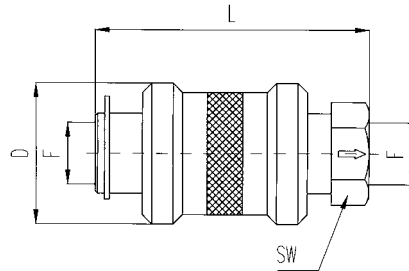

F NPTF	Part Number	DIMENSIONS		
		L	D	SW
1/8	IN530-020-020	1.89	0.98	0.55
1/4	IN530-021-021	2.28	1.18	0.75
3/8	IN530-022-022	2.76	1.38	0.87
1/2	IN530-023-023	3.15	1.57	1.06

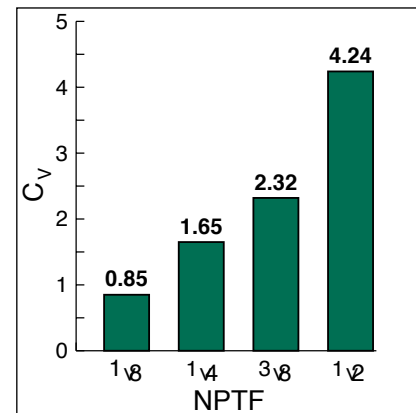

### OA22-1 Shuttle Valve

#### Specifications

Temperature Range: -4° to 194° F

Pressure Range: 3.9 to 145 PSI

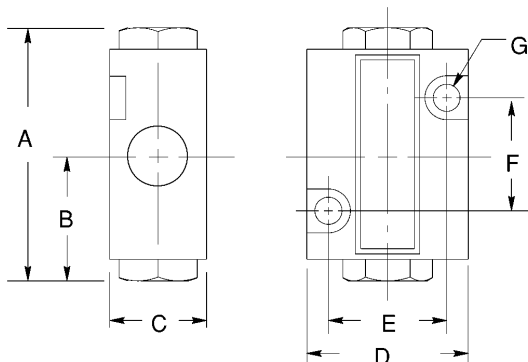

Ports NPTF	OA22-1	DIMENSIONS						
		A	B	C	D	E	F	G
1/8	OA22-1	1.93	.95	.75	1.26	.91	.87	.20



## Silencers

### M Series Metal Air Silencers

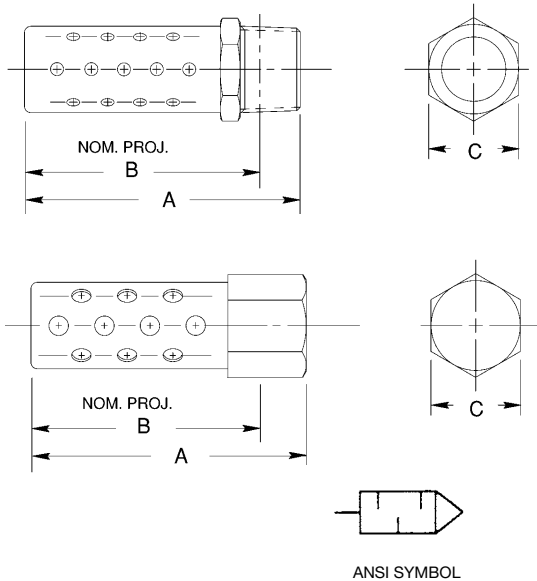

#### Application:

The M Series muffler softly exhausts air and disperses it over a 360° pattern. Constructed of a corrosion resistant metal, it can withstand shock and continuous, heavy duty use under many conditions. This muffler is ideal for use on the 22/32 Series Solenoid Soft Start Quick Exhaust Valve, Lockout Valves, valve exhaust ports, single acting cylinders, and many other applications.

#### NPTF Male Dimensions

Model	NPTF	A	B	C	cv
M1MN	1/8	1.38 (34.9)	1.22 (31.0)	0.44 (11.1)	1.17
M2MN	1/4	1.75 (44.5)	1.53 (38.9)	0.56 (14.3)	2.54
M3MN	3/8	2.25 (57.2)	2.00 (50.8)	0.69 (17.5)	5.08
M4MN	1/2	2.72 (69.1)	2.41 (61.1)	0.88 (22.2)	7.32
M5MN	3/4	3.16 (80.2)	2.81 (71.4)	1.06 (27.0)	13.87
M6MN	1	3.88 (98.4)	3.47 (88.1)	1.31 (33.3)	19.53
M7MN	1 1/4	4.50 (114.3)	4.16 (105.6)	1.69 (42.9)	28.32
M8MN	1 1/2	5.00 (127.0)	4.59 (116.7)	2.00 (50.8)	38.09
M9MN	2	5.50 (139.7)	5.06 (128.6)	2.38 (60.3)	52.73

#### NPTF Female Dimensions

Model	NPTF	A	B	C	cv
M1FN	1/8	1.38 (34.9)	1.22 (31.0)	0.50 (12.7)	1.17
M2FN	1/4	1.75 (44.5)	1.53 (38.9)	0.62 (15.9)	2.54
M3FN	3/8	2.25 (57.2)	2.00 (50.8)	0.75 (19.1)	5.08
M4FN	1/2	2.72 (69.1)	2.41 (61.1)	0.94 (23.8)	7.32

#### BSPT Male Dimensions

Model	NPTF	A	B	C	cv
M1MB	1/8	1.38 (34.9)	1.22 (31.0)	0.44 (11.1)	1.17
M2MB	1/4	1.75 (44.5)	1.53 (38.9)	0.56 (14.3)	2.54
M3MB	3/8	2.25 (57.2)	2.00 (50.8)	0.69 (17.5)	5.08
M4MB	1/2	2.72 (69.1)	2.41 (61.1)	0.88 (22.2)	7.32
M5MB	3/4	3.16 (80.2)	2.81 (71.4)	1.06 (27.0)	13.87
M6MB	1	3.88 (98.4)	3.47 (88.1)	1.31 (33.3)	19.53

### SSM Series Stainless Steel Air Silencers

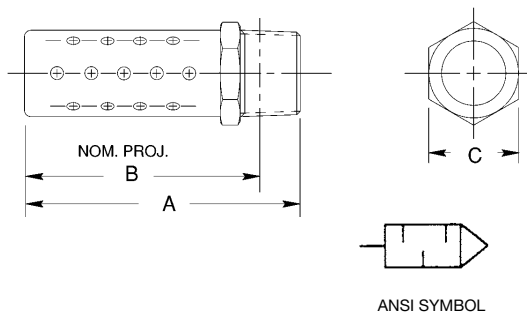

#### NPTF Male Dimensions

Model	NPTF	A	B	C	cv
SSM1MN	1/8	1.38 (34.9)	1.22 (31.0)	0.44 (11.1)	1.17
SSM2MN	1/4	1.75 (44.5)	1.53 (38.9)	0.56 (14.3)	2.54
SSM3MN	3/8	2.25 (57.2)	2.00 (50.8)	0.69 (17.5)	5.08
SSM4MN	1/2	2.72 (69.1)	2.41 (61.1)	0.88 (22.2)	7.32
SSM5MN	3/4	3.16 (80.2)	2.81 (71.4)	1.06 (27.0)	13.87
SSM6MN	1	3.88 (98.4)	3.47 (88.1)	1.31 (33.3)	19.53

#### Application:

The SSM Series Muffler is constructed with 300 Series stainless steel. Resistant to atmospheric corrosion, sterilizing solutions, organic chemicals, and many inorganic chemicals makes this a terrific product for dairy and food plants. The SSM Series Muffler softly exhausts air and disperses it over a 360° pattern. Because of its heavy-duty construction, it can withstand shock and continuous cycling.



**Silencers**

**P Series Porous Bronze Air Silencers**

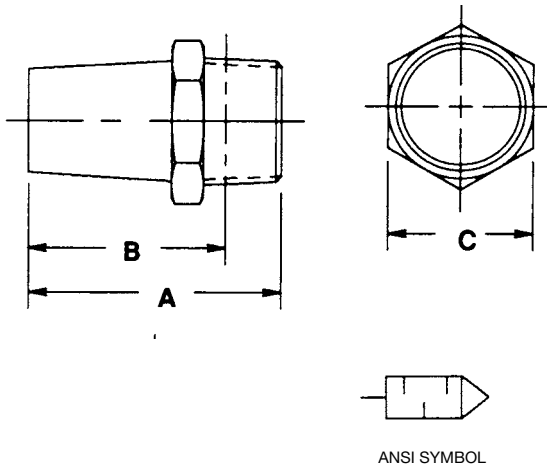

**Application:**

The P Series muffler is perfect for limited space applications due to its compact size. This silencer can be used to muffle air valve exhaust noise, intake filtration, coalescing of oil mist exhaust, pressure or vacuum equalization, or on any other liquid vapor.

**NPTF Male Dimensions**

Model	NPTF	A	B	C	cv
P0MN	10-32	0.75 (19.1)	0.62 (15.7)	0.38 (9.5)	0.23
P1MN	1/8	0.84 (21.4)	0.69 (17.5)	0.44 (11.1)	1.07
P2MN	1/4	1.20 (30.6)	0.97 (24.6)	0.56 (14.3)	1.78
P3MN	3/8	1.45 (36.7)	1.20 (30.6)	0.69 (17.5)	2.30
P4MN	1/2	1.89 (48.0)	1.58 (40.1)	0.88 (22.2)	5.66
P5MN	3/4	2.12 (54.0)	1.78 (45.2)	1.06 (27.0)	9.67
P6MN	1	2.84 (72.2)	2.44 (61.9)	1.31 (33.3)	14.06
P7MN	1 1/4	3.44 (87.3)	3.00 (76.2)	1.69 (42.9)	20.51
P8MN	1 1/2	4.00 (101.6)	3.56 (90.5)	2.00 (50.8)	29.10
P9MN	2	4.75 (120.7)	4.31 (109.5)	2.38 (60.3)	44.92

**BSPT Male Dimensions**

Model	NPTF	A	B	C	cv
P1MB	1/8	0.84 (21.3)	0.69 (17.5)	0.44 (11.1)	1.07
P2MB	1/4	1.20 (30.5)	0.97 (24.6)	0.56 (14.3)	1.78
P3MB	3/8	1.45 (36.8)	1.20 (30.5)	0.69 (17.5)	2.30
P4MB	1/2	1.89 (48.0)	1.58 (40.1)	0.88 (22.2)	5.66
P5MB	3/4	2.12 (53.9)	1.78 (45.2)	1.06 (27.0)	9.67
P6MB	1	2.84 (72.1)	2.44 (62.0)	1.31 (33.3)	14.06

**E Series Polyethylene Air Silencers**

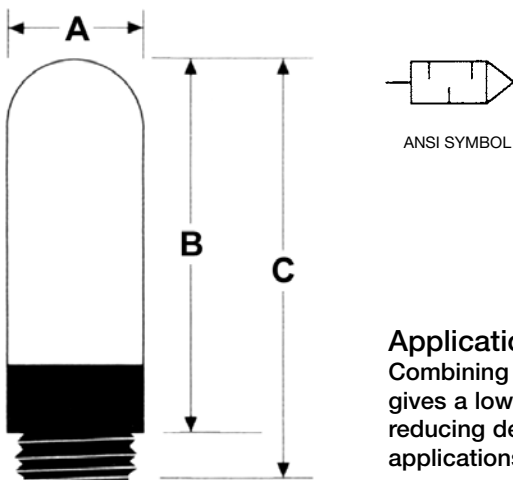

**NPTF Male Dimensions**

Model	NPTF	A	B	C
E1MN	1/8	0.49 (12.5)	1.1 (28.3)	1.3 (34.0)
E2MN	1/4	0.61 (15.5)	1.4 (35.5)	1.7 (42.5)
E3MN	3/8	0.73 (18.5)	2.2 (56.0)	2.7 (67.5)
E4MN	1/2	0.93 (23.5)	2.6 (67.0)	3.1 (78.0)
E5MN	3/4	1.50 (38.5)	4.9 (123.5)	5.5 (140.0)
E6MN	1	1.90 (49.0)	5.5 (140.5)	6.3 (160.0)

**Application:**

Combining a sturdy nylon thread with a polyethylene body, the E Series silencer gives a low-cost, light weight alternative to heavier, metal-based mufflers while reducing decibel levels to an OSHA approved level. It is perfect for robotic arm applications, low-traffic or enclosed areas, or where cost is of primary concern.



## Mufflers

### Bronze Speed Control Muffler

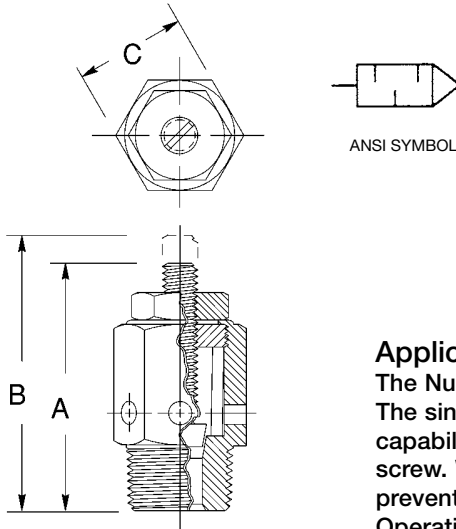

#### Model Selection

Port Size	Models NPT	Cv	DIMENSIONS		
			A	B	C
1/8	A1MN	0.35	1.12 (28.0)	1.31 (33.0)	0.50 (13.0)
1/4	A2MN	0.67	1.42 (36.0)	1.56 (40.0)	0.63 (16.0)
3/8	A3MN	0.90	1.47 (32)	1.63 (41.0)	0.69 (18.0)
1/2	A4MN	1.35	1.75 (44)	2.00 (51.0)	0.88 (22.0)
3/4	A5MN	1.67	2.00 (51)	2.38 (60.0)	1.06 (27.0)
1	A6MN	2.32	2.25 (57)	2.50 (63.0)	1.31 (33.0)

#### Application:

The Numatics Bronze Speed Control Muffler provides infinite metering of air flow. The sintered bronze is encased by an outer metal shroud. With linear adjusting capability, the speed of the cylinder can be decreased by adjusting the integrated screw. When optimal exhaust rate is reached, the locknut may be adjusted to prevent accidental adjustments due to vibration or other means. Maximum Operating Pressure: 300 PSI Temperature Range: 35°-300°F (1.7°-149°C)

### Polyethylene Speed Control Muffler

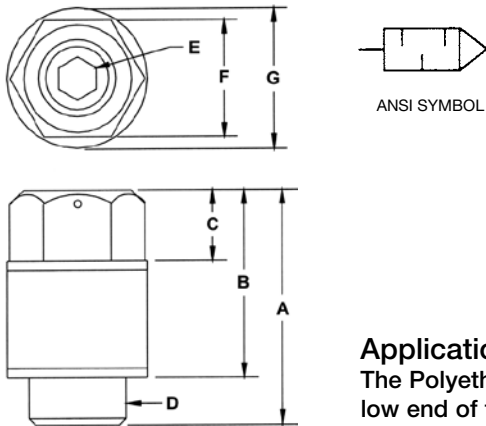

#### Model Selection

Port Size	Models NPT	DIMENSIONS						
		A	B	C	D	E	F	G
M5	S0MN	0.52 (16.0)	0.36 (11.0)	0.36 (11.0)	M5	0.05 (1.5)	3.1 (79.0)	0.30 (9.2.0)
1/8	S1MN	0.69 (21.0)	0.49 (15.0)	0.16 (5.0)	1/8 NPT	0.08 (2.5)	5.1 (130.0)	0.49 (15.0)
1/4	S2MN	0.95 (29.0)	0.72 (22.0)	0.23 (7.0)	1/4 NPT	0.13 (4.0)	5.9 (150.0)	0.59 (18.0)
3/8	S3MN	1.2 (38.0)	0.98 (30.0)	0.36 (11.0)	3/8 NPT	0.20 (6.0)	7.9 (200.0)	0.79 (24.0)
1/2	S4MN	1.6 (50.0)	1.3 (40.0)	0.49 (15.0)	1/2 NPT	0.26 (8.0)	8.4 (213.0)	0.98 (30.0)

#### Application:

The Polyethylene Speed Control Muffler is designed to give fine adjustment to the low end of the flow range, followed by more coarse control as flow is increased toward the maximum. The body is made of highly versatile and cost-effective nylon. The adjusting screw is made of high tensile steel and is coated with electroplated zinc. The S Series muffler reduces decibel levels to an OSHA approved level.



**Breather Vent Silencer and Inlet Filter Strainer**

**Breather Vent Silencer**

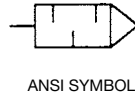
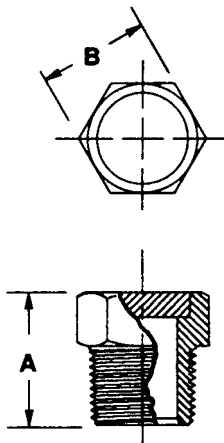

**Model Selection**

Port Size	Models			DIMENSIONS	
	NPT	BSPT	Cv	A	B
1/8	B1MN	B1MB	0.44	0.44 (11.0)	0.44 (11.0)
1/4	B2MN	B2MB	0.65	0.63 (16.0)	0.56 (14.0)
3/8	B3MN	B3MB	1.12	0.75 (19.0)	0.68 (17.0)
1/2	B4MN	B4MB	1.77	0.88 (22.0)	0.88 (22.0)
3/4	B5MN	B5MB	4.72	1.00 (25.0)	1.06 (27.0)
1	B6MN	B6MB	7.30	1.31 (33.0)	1.31 (33.0)
1 1/4	B7MN	B7MB	10.63	1.41 (50.0)	1.68 (43.0)
1 1/2	B8MN	B8MB	12.72	1.50 (38.0)	2.00 (51.0)

**Application:**

The Breather Vent offers some noise reduction, but is better suited for keeping contaminant out of valve exhaust ports, single-acting cylinder ports, or any other threaded port open to atmosphere which needs flow relief. It is also used on gear boxes, storage tanks, or wherever pressure equalization is needed. The Breather Vent is compact and inexpensive. Maximum Operating Pressure: 150 PSI Operating Temperature: 35°-300°F (1.7°-149°C)

**Inlet Filter Strainer**

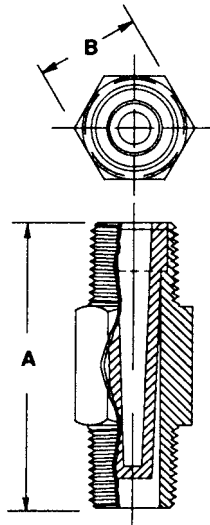

**Model Selection**

Port Size	Models NPT	Cv	DIMENSIONS	
			A	B
1/8	C1MN	0.31	1.25 (32.0)	0.43 (11.0)
1/4	C2MN	0.78	1.50 (38.0)	0.56 (14.0)
3/8	C3MN	1.0	1.75 (44.0)	0.69 (17.0)
1/2	C4MN	2.0	2.00 (51.0)	0.88 (22.0)

**Application:**

Ideal for air, oil, or water, the C Series Inlet Filter Strainer is compact and light weight - perfect for point of use application. It features a brass fitting which contains a cone-shaped, sintered bronze, 40 micron filter. It is used as a prefilter which eliminates bulk contamination from air lines, extending the life of filter elements and other downstream components.



## Check Valves

### CV Series Check Valves

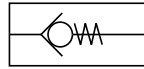
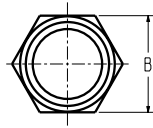
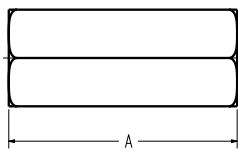

ANSI SYMBOL

### Model Selection

Port Size	Models NPT	DIMENSIONS	
		A	B
1/8	CV1FN	1.75	9/16" Hex
1/4	CV2FN	2.00	11/16" Hex
3/8	CV3FN	2.00	7/8" Hex
1/2	CV4FN	2.50	1" Hex

### Specifications

Operating Temperature: 0° to 140° F  
(5° to 60°C)

Operating Pressure: 3.5 to 213 PSIG  
(0.24 to 14.69 bar)

### Materials of Construction

Body: Nickel Plated Brass

Valve: Brass

### Application:

Numatics CV Series Check Valves are used in fluid systems to permit free flow of air in on direction and prevent the flow in the opposite direction. Each check valve is clearly marked with a direction arrow to prevent accidental misconnection.



## Tubing

### QR300071 Tube Cutter

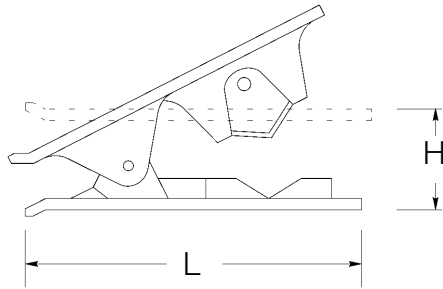

This tool will cut all composite tubes (e.g. nylon, teflon, polyurethane, braided polyethylene, soft rubber, etc.) from 1/8" to 1/2" diameter inclusive. It is designed to give a clean cut at right angles to tube axis. A spring maintains the cutter in the closed position.

Model No.	Height	Length
QR3000 71 00	.98	3.11

### Tubing How to Order

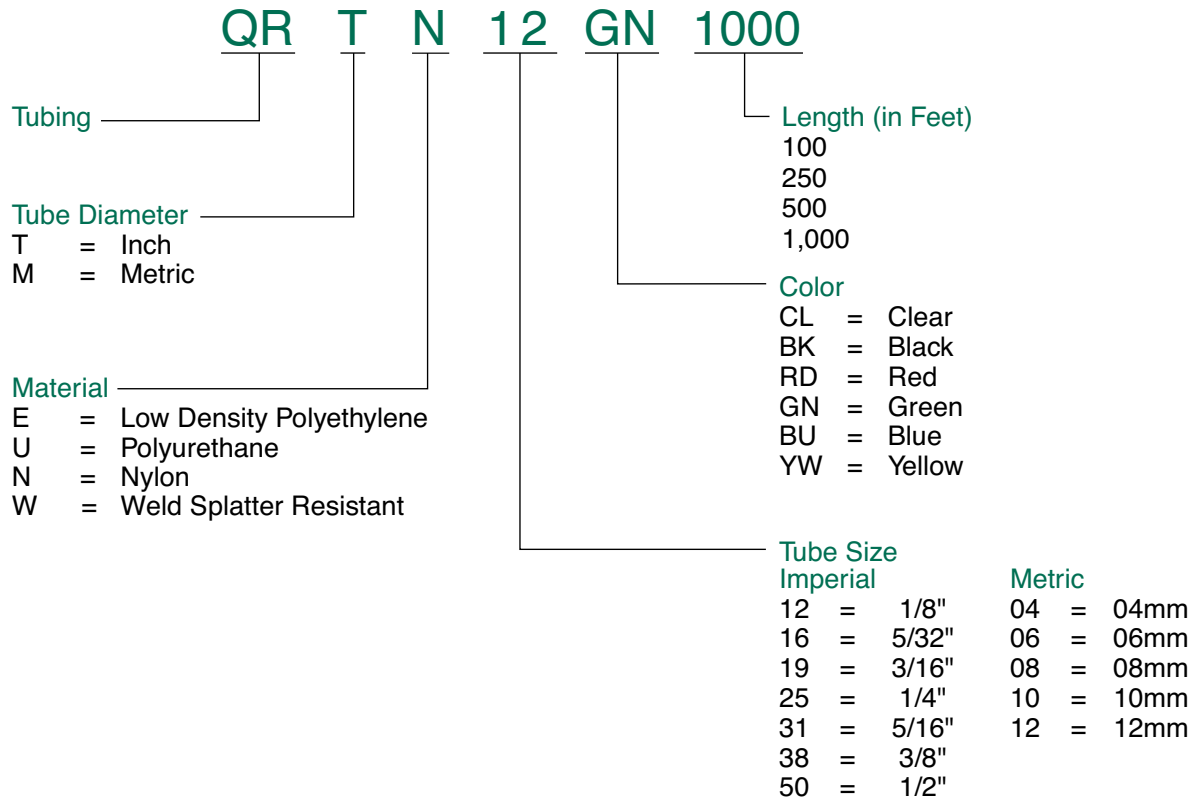





### Polyurethane 95 Tubing

#### Application

Polyurethane tubing is ideal for compressed air and vacuum systems. This rigid wall tubing is compatible with push to connect pneumatic fittings.

#### Features

Has excellent abrasion resistance and shape retention while working in high humidity and low temperatures. Withstands salt water, ages well, has good vibration absorption, and excellent tear resistance.

#### Specifications

- Vacuum to 28" Hg
- Temperature Range: -40° to 165° F
- UV Stabilized
- Shore 95 A
- NSF61 Compliant
- Meets UL94HB
- Dimensional Tolerance
  - Imperial ±.005 in.
  - Metric ±.127 mm

#### Inch

MODEL NUMBER*	O.D. (in.)	I.D. (in.)	WALL (in.)	MIN. BEND RADIUS	WORKING PRESSURE (PSIG)				WEIGHT lbs/100'
					@ 75°F	@ 100°F	@ 125°F	@ 150°F	
QRTU12__	1/8	.066	.030	1/4	233	172	140	117	0.5
QRTU16__	5/32	.093	.031	3/8	176	130	106	88	0.7
QRTU19__	3/16	.107	.040	3/8	150	111	90	75	1.0
QRTU25__	1/4	.160	.045	1/2	148	110	89	74	1.5
QRTU31__	5/16	.216	.048	3/4	133	98	80	67	3.9
QRTU38__	3/8	.245	.065	7/8	147	109	88	74	3.4
QRTU50__	1/2	.375	.090	1-1/8	140	104	84	70	5.1

#### Metric

MODEL NUMBER*	O.D. (mm)	I.D. (mm)	WALL (mm)	MIN. BEND RADIUS	WORKING PRESSURE (PSIG)				WEIGHT lbs/100'
					@ 75°F	@ 100°F	@ 125°F	@ 150°F	
QRMU04__	4	.24	0.8	3/8	176	130	106	88	0.7
QRMU06__	6	4.0	1.0	1/2	145	107	87	73	1.3
QRMU08__	8	5.0	1.5	3/4	155	115	93	78	2.6
QRMU10__	10	6.5	1.75	7/8	149	110	89	75	3.9
QRMU12__	12	8.0	2.0	1-1/8	133	98	80	67	5.3

\*See page 43 for complete model number information.

### Polyurethane Tubing for Numatrol™ Series

#### Application

This highly flexible tubing allows easy connection to “barbed” fittings with sharp bends possible in less than one inch. Many Numatrol™ installations that previously required the use of nylon tubing for high pressure, clamp functions for example, can now be easily accomplished with this tubing.

#### Features

Numatrol™ polyurethane tubing offers superior performance to other composite tubing with regard to kink resistance. Low temperature flexibility, higher working pressures, and resistance to ambient ozone oil, grease, fuels and most chemicals.

#### Specifications

- Vacuum to 28" Hg
- Temperature Range: -0° to 200° C
- Shore 83 A

MODEL NUMBER	O.D. (in.)	I.D. (in.)	WALL (in.)	TOLERANCE		WORKING PRESSURE (PSIG)						ROLL LENGTH
				O.D.	I.D.	@ 0°C	@ 40°C	@ 80°C	@ 120°C	@ 160°C	@ 200°C	
135-124	1/4	1/8	.031	±.008	±.005	180	135	97	60	48	22	1000 ft.
135-125	1/4	1/8	.031	±.008	±.005	180	135	97	60	48	22	100 ft.
135-127	1/8	1/16	.015	±.005	±.005	180	135	97	60	48	22	1000 ft.
135-126	1/8	1/16	.015	±.005	±.005	180	135	97	60	48	22	100 ft.



## Low-Density Polyethylene Tubing

- Lightweight and flexible
- Superior dielectric properties
- Easily heat sealed
- Tasteless and odorless
- Impermeable to gasses and moisture

LDPE is extruded to close tolerances from high quality low density polyethylene resins. All colors except red, comply with FDA regulation 21 CFR 177.1520(c) for food contact applications. LDPE has a water absorption rate of 0.15% per ASTM D-570 standards.

### Specifications

- Temperature Range: All Diameters: -40° to 150°F
- Vacuum Rating: to 28" Hg.
- Diameter Tolerances: +.004"
- Hardness: LDPE: 44 Shore D
- Tube Markings: FW Specifications
- Working Pressure: 3:1 Safety Factor
- Base Resin Compliance: FDA (except red) NSF51(LLDPE)
- Recommended Fittings: LDPE: Push-In, Compression

### Inch

MODEL NUMBER	O.D. (in.)	I.D. (in.)	WALL (in.)	Working Pressure (PSIG)		Bend Radius (in)
				@75°F	@150°F	
QRTE12	1/8	.062	.031	305	120	1/2
QRTE16	5/32	.106	.025	175	70	1
QRTE25	1/4	.170	.040	200	80	1-1/4
QRTE31	5/16	.187	.062	230	90	1-1/2
QRTE38	3/8	.250	.062	190	75	2
QRTE50	1/2	.375	.062	135	55	2-1/2

### Metric

MODEL NUMBER	O.D. (mm)	I.D. (mm)	WALL (mm)	Working Pressure (PSIG)		Bend Radius (mm)
				@75°F	@150°F	
QRME04	4	2.7	.65	175	70	25.2
QRME06	6	4	1	175	70	31.8
QRME08	8	6	1	140	55	38
QRME10	10	8	1	115	45	51
QRME12	12	9	1.5	135	55	63.5

## Nylon 11 Tubing

### Application

Flexible nylon tubing used for air and lubrication lines, instrumentation and process lines for chemicals and solvents. Contact factory for specific applications.

### Features

Has excellent resistance to a wide range of chemicals including petroleum products, soaps, salt solutions and bases.

### Specifications

- Temperature Range: -60° to 200°F
- Vacuum Rating: to 28" Hg.
- Diameter Tolerances: .002", -.004"
- Metric: +.051 mm, -.1 mm
- Hardness: 78 Rockwell R
- Working Pressure: 4:1 Safety Factor
- UV Stabilized: Yes
- Base Resin Compliance: Meets UL94HB Testing Requirements
- Recommended Fitting: Push-In, compression

### Inch

MODEL NUMBER	O.D. (in.)	I.D. (in.)	WALL (in.)	Min. Bend Radius	Working Pressure (PSIG)			
					@75°F	@100°F	@125°F	@150°F
QRTN12__	1/8	.093	.017	3/8	225	168	133	125
QRTN16__	5/32	.106	.025	1/2	275	200	169	160
QRTN19__	3/16	.138	.024	5/8	225	158	120	113
QRTN25__	1/4	.180	.035	1	250	183	160	140
QRTN31__	5/16	.232	.040	1-1/4	220	170	141	121
QRTN38__	3/8	.275	.050	1-1/2	220	165	148	128
QRTN50__	1/2	.375	.062	2	200	145	133	125

### Metric

MODEL NUMBER	O.D. (mm)	I.D. (mm)	WALL (mm)	Min. Bend Radius	Working Pressure (PSIG)			
					@75°F	@100°F	@125°F	@150°F
QRMN04__	4	2.7	.6	12.7	350	263	228	210
QRMN06__	6	4	1	17	340	255	221	200
QRMN08__	8	6	1	38	250	187.5	162.5	150
QRMN10__	10	8	1	51	190	142.5	123.5	110
QRMN12__	12	10	1	76	150	112.5	97.5	90



## Weld Splatter Tubing

### Weld Spatter Resistant

#### Features

- Protects tube from incidental weld splatter contact
- Flexible with an excellent bend radius
- Resistant to kink damage
- Broad range of chemical resistance
- Can be formed into retractable coils

#### Specifications

- Temperature Range: All Diameters: -40°F to +165°F
- Vacuum Rating: to 28" Hg.
- Diameter Tolerances: +/- .005" Inner
- Working Pressure: 3:1 Safety Factor
- Base Resin Compliance:
  - Outer Jacket: Meets UL94VO Testing Requirements
  - Inner Tube: Meets UL94HB Testing Requirements
- Recommended Fittings: Push-In, Compression

#### Metric

MODEL NUMBER	O.D. (mm)	I.D. (mm)	Working Pressure (PSIG)		Weight (lbs/100ft)	Bend Radius (mm)
			@25°F	@65°F		
QRMW06	6	4	160	65	2.59	12.7
QRMW08	8	5	190	75	4.15	19
QRMW10	10	6.5	170	70	5.71	22.2
QRMW12	12	8	155	60	7.43	28.6

# NUMATICS

*World Class Supplier  
of Pneumatic Components*

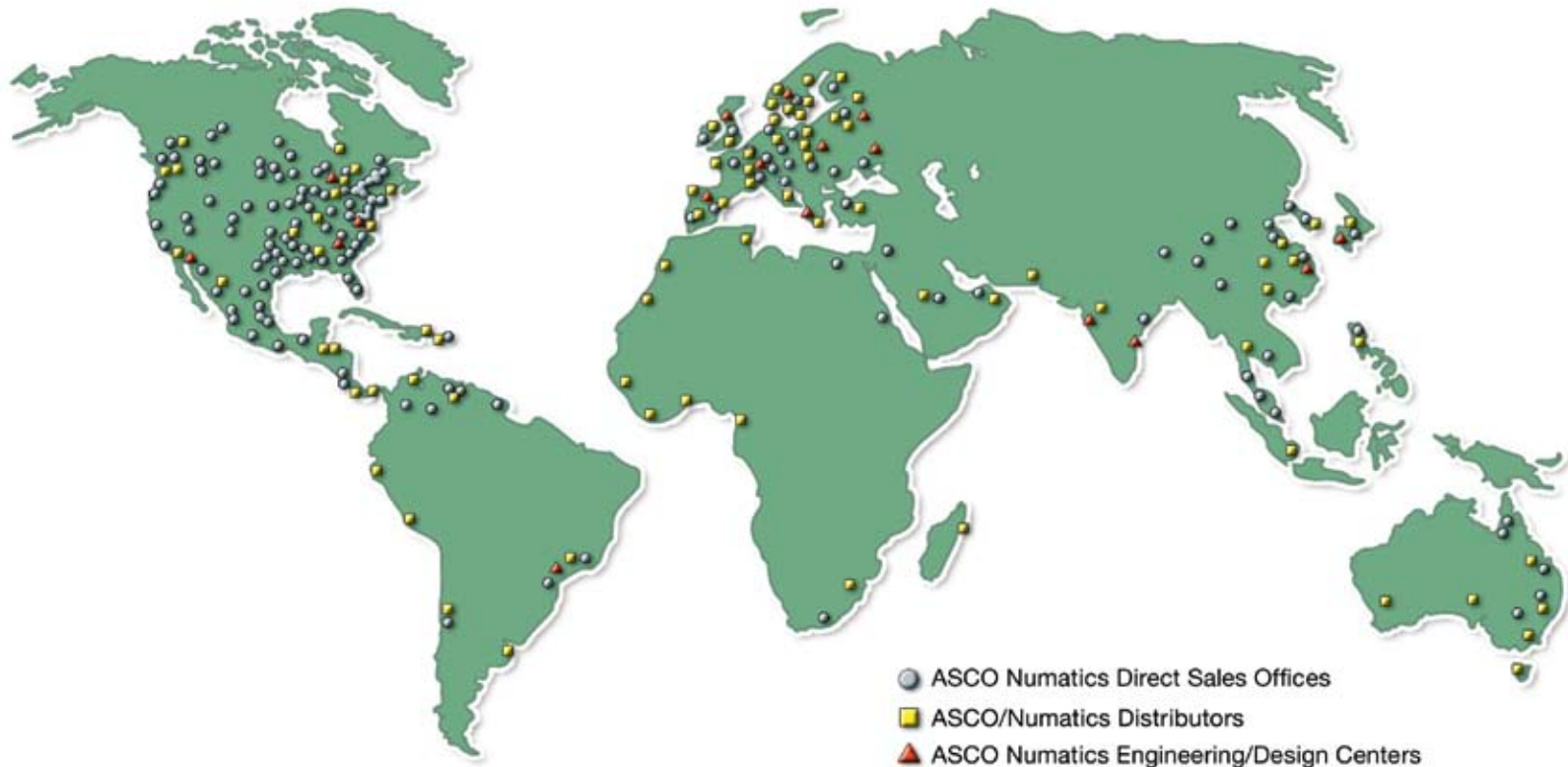

## WORLD HEADQUARTERS

### USA

#### Numatics, Incorporated

46280 Dylan Drive  
Novi, Michigan 48377

P: 1-888-Numatics  
1-888-686-2842

### Canada

#### Numatics, Ltd

P: 519-452-1777

### Mexico

#### Numatics de Mexico S.A. de C.V.

P: 52-222-284-6176

For a comprehensive listing of all Numatics production and distribution facilities worldwide, visit:

[www.numatics.com](http://www.numatics.com)